



Commercial Self-Contained

IntelliPak® Signature Series
20-80 Ton Water-Cooled Air Conditioners
20-60 Ton Air-Cooled Air Conditioners
Remote Air-Cooled Condensers





Introduction

Affordable Self-Contained Value from Trane...

INTELLIPAK®

Signature Series Self-Contained Units

Trane's advanced technology brings unmatched reliability, high performance, and affordable cost!

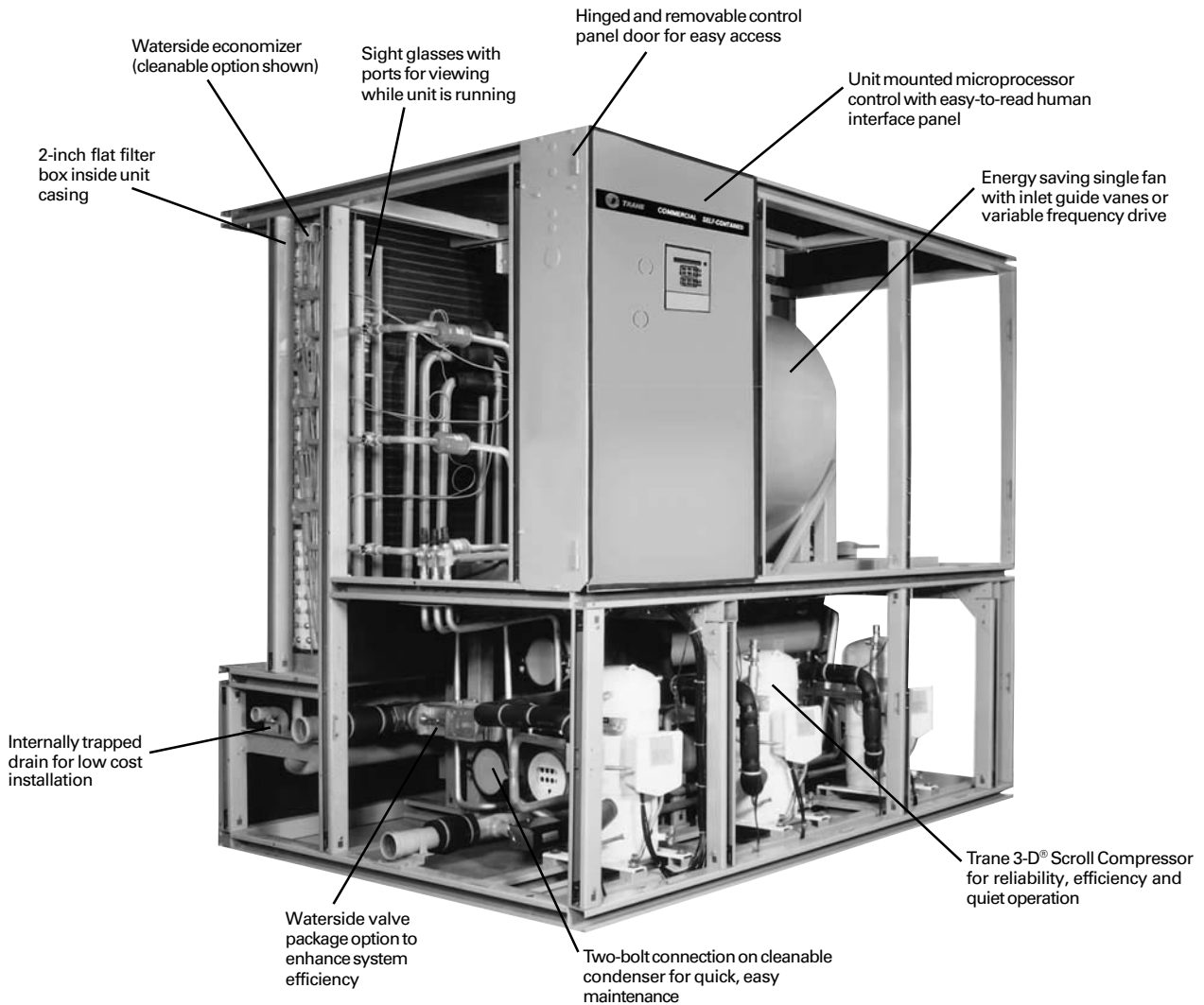

Contents

Introduction	2
Features and Benefits	4
Application Considerations	8
Selection Procedure	12
Model Number Description	14
General Data	17
Performance Data	22
Airside Pressure Drops	22
Waterside Pressure Drops	29
Water-Cooled Units	31
Air-Cooled Units	60
Heating Coils	68
Controls	69
Electrical Data	79
Dimensions and Weights	81
Mechanical Specifications	95
Options	97



Features and Benefits

Why consider the Signature Series self-contained floor-by-floor systems?

Improved Cash Management

- Factory-installed and tested options reduce field labor and installation risk, while improving system reliability
- Requires less sophisticated maintenance than built-up systems

Tenant Satisfaction

- Complete HVAC system on each floor minimizes tenant inconvenience during routine maintenance
- Tenants can control system after hours to increase productivity and minimize expense

Low First Cost

- Reduce field labor, installation time, and cost with factory packaged controls and piping
- Reduce installed tonnage up to 20 percent by taking advantage of building diversity and VAV flexibility
- Flexible air discharge arrangement matches most building configurations

Lower Installed Cost

- Single point power connection
- Single point water connection
- Factory commissioned and tested controls
- Factory installed options
- Internally trapped drain connection

Economical Operation

- Free cooling with waterside or airside economizer
- Energy savings with floor-by-floor system since only units on floors requiring cooling need to operate
- Significant annual energy consumption reduction due to partial occupancy after-hours, when compared to a central chilled water system
- Simple heating alternatives include perimeter radiation and fan-powered VAV
- Energy savings from the integrated water valve control using pump unloading

Assured Acoustical Performance

- Flexible, horizontal discharge plenum provides smooth airflow, reducing static pressure losses for optimum acoustical performance

- Multiple compressor design reduces acoustical levels. Scroll compressor design smooths gas flow for quieter operation

Indoor Air Quality (IAQ) Features

- Sloped drain pan
- Stainless steel sloped drain pan option
- Internally trapped drain connection
- Double wall construction option
- Matt-faced fiberglass insulation
- High efficiency throwaway filter option
- Easily cleanable evaporator, condensers, and waterside economizers
- Filter access door allows easy removal to encourage frequent filter changing
- Airside economizer with Traq™ damper allows direct measurement and control of outdoor air

Enhanced Serviceability

- Self-supporting removable panels
- Quick access service panel fasteners
- Eye level control/service center
- Refrigerant line sight glasses in view during operation

Features and Benefits

Standard Features

- 20 through 80 ton industrial/commercial water-cooled self-contained units
- 20 through 60 ton industrial/commercial remote air-cooled self-contained units
- Fully integrated, factory-installed, and commissioned microelectronic controls
- Unit mounted human interface panel with a two line x 40 character clear language (English, Spanish, or French) display and a 16-function keypad that includes custom, diagnostics, and service test mode menu keys
- Improved Trane 3-D® scroll compressor
- Compressor lead/lag
- CV or VAV system control
- Low ambient compressor lockout adjustable control input
- FROSTAT™ coil frost protection on all units
- Daytime warmup (occupied mode) on units with heat and morning warmup operation on all units
- Supply air static overpressurization protection on units with inlet guide vanes or variable frequency drives (VFD's)
- Supply airflow proving
- Supply air tempering control with heating option
- Supply air heating control on VAV with hydronic heating option
- Emergency stop input
- Mappable sensors and setpoint sources
- Occupied/unoccupied switching
- Timed override activation
- Refrigeration circuits are completely factory piped and tested on water-cooled units
- Factory piped and tested, mechanically cleanable water-cooled condensers
- Two-bolt removable condenser waterboxes for quick and easy cleaning
- Sloped drain pans to ensure complete condensate removal for IAQ
- Internally trapped drain connection with cleanout
- Internally isolated centrifugal supply fan
- 14-gauge galvanized steel framework with easily removable painted exterior panels of 18-gauge galvanized steel
- UL listing on standard options
- Fan belts and grease lines are easily accessible
- Access panels and clearance provided to clean both evaporator and waterside economizer coil fins

- Condensing pressure control on all variable water flow systems with valves
- Programmable water purge during unoccupied mode
- High entering air temperature limit
- Low entering air temperature limit with waterside economizer or hydronic heat

Optional Features

- Trane communication interface module: ICS interface control module
- Generic BAS interface
- Comparative enthalpy control
- Ventilation override from up to five external inputs
- Remote human interface controls up to four units
- Fully integrated, factory-installed/commissioned variable frequency drive control with or without optional integrated bypass
- Fully integrated, factory-installed and commissioned inlet guide vanes on FC supply fan
- Waterside economizer with factory installed piping and controls
- Waterside modulating condensing temperature control valves include factory installed piping and control wiring
- Removable cast iron headers on cleanable waterside economizer
- Flexible horizontal discharge plenum with or without factory cut holes
- Heating options include hot water, steam, and electric
- Refrigerant suction discharge line service (shut-off) valves
- Protective coatings for the unit and/or evaporator coils
- Double wall construction
- Stainless steel sloped drain pan
- Medium efficiency throwaway filters
- Through-the-door non-fused disconnect switch
- Trane's air quality Traq™ damper in airside economizer mixing box
- High duct temperature thermostat
- Dual electrical power connection
- CO₂ reset input

FC Fans With Inlet Guide Vanes

Trane's forward-curved fans with inlet guide vanes pre-rotate the air in the direction of the fan wheel. This decreases static pressure and horsepower. The unloading characteristics of a Trane FC fan with inlet guide vanes results in superior part load performance.

Variable Frequency Drives (VFD)

Variable frequency drives are factory installed, wired, and tested to provide supply fan motor speed modulation. VFD's are quieter and more efficient than inlet guide vanes and may even be eligible for utility rebates. The VFD's are available with and without a manual integrated bypass option, controlled through the human interface (HI) panel. Bypass control provides full nominal airflow control to CV zone setpoints in the unlikely event of a drive failure by manually placing the drive in the bypass mode.

Field Installed Accessories

- Airside economizer control with or without mixing box
- Programmable sensors with or without night set back for CV and VAV systems
- ICS zone sensors used with Tracer® system for zone control
- Field installed module kits available for field upgrade of controls
- Ultra low leak dampers for 0-100 percent modulating fresh air economizer

Features and Benefits

Integrated Self-Contained Systems

Integrated Comfort™ System (ICS)

Trane's Integrated Comfort™ system (ICS) increases job control by combining IntelliPak® Signature Series self-contained units and a Tracer® building management system. This integrated system provides total building comfort and control. Building owners and managers not only save energy when using ICS—they have the ability to automate their facilities and the convenience of a control system interface.

Simplifying The Comfort System

Trane's designers combined new technology and innovation to bring you more system capabilities and flexibility. Our Integrated Comfort™ system (ICS) with HVAC equipment is easy to use, install, commission, and service.

Everything you need to know about your self-contained VAV system is available using Tracer®, Trane's family of building automation products. Tracer® is a software package that minimizes custom programming requirements and allows easy system setup and control using your personal computer. Operating data from all system components is readily available for evaluation. You can control, monitor, and service your facility—all from your personal computer.

The IntelliPak® self-contained unit, as part of Trane ICS, provides powerful maintenance monitoring, control, and reporting capabilities. Tracer® places the self-contained unit in the appropriate operating mode for: system on/off, night setback, demand limiting, setpoint adjustment based on outside parameters and much more. You can monitor unit diagnostic conditions through Tracer such as: sensor failures, loss of supply airflow, and an inoperative refrigerant circuit.



IntelliPak® Signature Series self-contained monitoring points available using Tracer®

- Compressor on/off status
- Ventilation status
- Condenser water flow status
- Heat status
- Supply air pressure
- Supply air temperature
- Suction temperature of each circuit
- Entering economizer water temperature
- Zone temperature
- Entering condenser water temperature
- Supply air temperature reset signal
- Morning warmup sensor temperature
- Entering air temperature

Tracer control points for IntelliPak® Signature Series Self-Contained Units

- Cooling and heating setpoints
- VAV discharge air temperature setpoints
- Supply air pressure setpoint
- Cooling and heating enable/disable
- Air economizer enable/disable
- Airside economizer minimum position
- Unit priority shutdown

Commissioning, control, efficiency, and information...it simply all adds up to one reliable source... Trane.

Features and Benefits

Trane 3-D® Scroll Compressor

Simple Design with 70% Fewer Parts

Fewer parts than an equal capacity reciprocating compressor means significant reliability and efficiency benefits. The single orbiting scroll eliminates the need for pistons, connecting rods, wrist pins, and valves. Fewer parts lead to increased reliability. Fewer moving parts, less rotating mass, and less internal friction means greater efficiency than reciprocating compressors.

Patented 3-D Scroll Compliance

Trane 3-D scroll compliance provides important reliability and efficiency benefits. 3-D compliance allows the orbiting scrolls to touch in all three dimensions, forming a completely enclosed compression chamber that leads to increased efficiency. In addition, 3-D compliance means the orbiting scrolls only touch with enough force to create a seal—so there is no wear between the scroll plates. The fixed and orbiting scrolls are made of high strength cast iron—resulting in less thermal distortion, less leakage, and higher efficiencies. The most outstanding feature of the scroll compressor 3-D compliance is that slugging will not cause failure. In a reciprocating compressor, however, liquid or dirt can cause serious damage.

Low Torque Variation

The 3-D scroll compressor has a very smooth compression cycle with torque variations that are only 30 percent of that produced by a reciprocating compressor. This means the scroll compressor imposes very little stress on the motor for greater reliability. Low torque variation means reduced noise and vibration.

Suction Gas Cooled Motor

Compressor motor efficiency and reliability are further optimized with this design. Cool suction gas keeps the motor cooler for longer life and better efficiency.

Proven Design Through Testing and Research

With over twenty years of development and testing, Trane 3-D scroll compressors have undergone more than 400,000 hours of laboratory testing and field operation. This work combined with over 25 patents makes Trane the worldwide leader in air conditioning scroll compressor technology.



One of two matched scroll plates — the distinguishing feature of the scroll compressor.

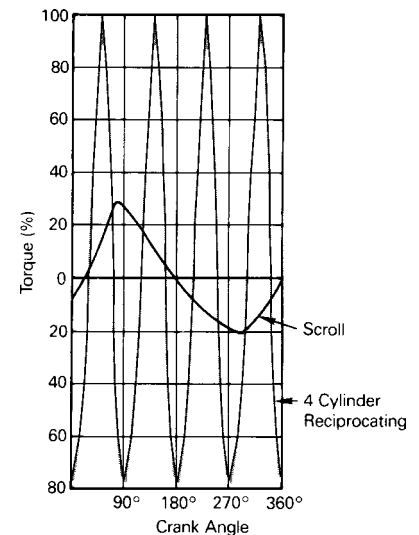

The Chart above illustrates low torque variation of 3-D Scroll compressors as compared to a reciprocating compressor.

Application Considerations Self-Contained

Self-Contained Acoustical Recommendations

Successful acoustical results are dependent on many system design factors.

Following are general acoustical recommendations. For more information, or if there is concern about a particular installation, contact a professional acoustical consultant.

Location and Orientation of the Mechanical Equipment Room

Locate the equipment room adjacent to stairwells, utility rooms, electrical closets, and rest rooms if possible (See figure below). This minimizes the acoustic effects and risk of workmanship or installation errors. Place the discharge and return air ductwork over these less acoustically sensitive areas, using vertical or horizontal fresh air shafts. Consult code requirements for fresh air and smoke purge constraints.

Return Air Ductwork

Duct the return air into the mechanical equipment room. Connect ductwork to the unit if local code dictates. The return air ductwork must have an elbow inside the equipment room. This elbow will reduce sound transmissions through the return duct. Extend the ductwork from the elbow far enough to block the “line of sight” to the exterior of the equipment room. Use a minimum ductwork length of 15 feet to the equipment room exterior. Line the duct with two-inch, three-pound density insulation. Use multiple, small return ducts for better acoustical performance to the occupied space.

Supply Air Ductwork

Insulate the supply air duct with two-inch, three-pound density insulation. Extend this lining at least 15 feet out from the equipment room wall, keeping the duct aspect ratio as small as possible. Minimize large flat panels since they

transmit sound. In addition, small aspect ratios will minimize potential “oil canning” of the duct due to flow turbulence.

The flexible horizontal discharge plenum option helps avoid complicated ductwork transitions. Ductwork turning vanes typically improve pressure drop but degrade acoustical performance.

Recommended Maximum Air Velocities

The maximum recommended velocity for the discharge air duct is 2,000 fpm. The maximum recommended velocity for the return air duct is 1,000 fpm. Limit air velocities below these operating points to minimize the risk of flow turbulence that causes regenerated noise. Using round supply duct and static regain allows maximum discharge air velocities up to 3,000 fpm. Lining round supply duct also substantially lowers frequency noise attenuation. However, flow regenerated noise potential increases dramatically at air velocities over 3000 fpm.

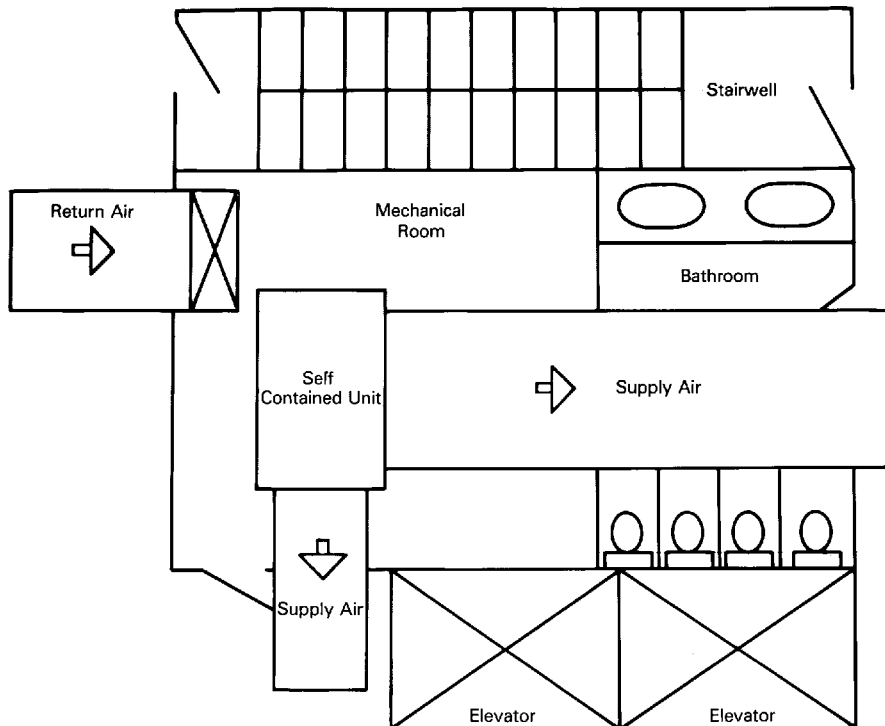

Equipment Room Location and Orientation

Application Considerations

Self-Contained

Equipment Room Construction Options

The preferred equipment room wall construction is concrete block. If this is not feasible then a double stud offset wall is suggested (See figure). This removes physical contact that would transmit sound through the equipment room wall to the occupied space. Interweave fiberglass insulation between the wall studs. Use two layers of sheetrock on each side of the wall.

Workmanship details are critical to acoustical performance. Seal all wall and floor penetrations by the ductwork, water piping, and equipment room access doors with a flexible material such as caulk and/or gasketing to stop noise and air leaks.

Locate the equipment room door away from acoustically sensitive areas like conference rooms. The door should swing out of the equipment room, if possible, so that the low pressure in the equipment room pulls the door in to help maintain a tight seal.

Equipment Options

The flexible horizontal discharge plenum allows multiple tested outlet options. This minimizes the risk of acoustic and/or pressure drop problems by avoiding complex transitions close to the fan discharge.

Static Pressure Versus Acoustics

Design the system to minimize the total static pressure required from the self-contained unit fan. Typically a change in static pressure of only 0.5 inches can reduce NC level by approximately 2 or 3 in the occupied space.

Isolation Recommendations

Unit

The Signature Series unit fan and compressors are internally isolated. Therefore, external isolation is not required. Consult a vibration specialist before considering external or double vibration isolation.

Ductwork

Design duct connections to the unit using a flexible material. Consult local codes for approved flexible duct material to prevent fire hazard potential.

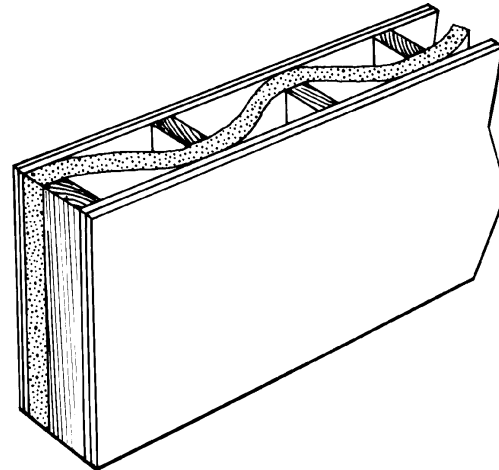

Double Stud Offset Wall with Interwoven Insulation

Piping Connections

Rubber isolator connectors are recommended for condenser piping to prevent vibration transmission to or from the building plumbing. The Signature Series self-contained unit is internally isolated and does not require additional isolation. However, ensure proper system vibration isolation design prevents vibration transmission from the building plumbing to the unit. Also be sure to properly isolate the drain line.

Condenser Water Piping

Piping Location and Arrangement

Provide at least 24 inches of clearance between the piping and the unit for service. Place the risers away from the side of the unit if possible. Be sure to allow sufficient space for valves and unions between the piping and the self-contained unit. Lay out condenser piping in reverse returns to help balance the system. This is accomplished by equalizing the supply and return pipe length. Multi-story buildings may use a direct return system with balancing valves at each floor. Install all heat exchangers and most cooling tower piping below the sump operating water level to prevent overflow during unit and/or system shut down.

Free Cooling Opportunities and Alternatives

Free cooling is available with either the airside or waterside economizer options.

Waterside Economizer

The waterside economizer substantially reduces the compressor energy requirements because it uses the cooling water before it enters the condensers. Additional equipment room space is not required since the coils are contained within the overall unit dimensions.

Disadvantages include higher airside pressure drop and a higher head on condenser water pumps.

The coils may be mechanically cleanable (optional) for ease in maintenance versus expensive and difficult chemical cleaning methods.

Airside Economizer

The airside economizer substantially reduces compressor, cooling tower, and condenser water pump energy requirements using outside air for free cooling. It also reduces tower make up water needs and related water treatment.

Disadvantages include building requirements that locate the mechanical room and self-contained unit toward an exterior wall to minimize ductwork, building barometric control, or additional air shafts. Also, airside economizers require additional mechanical room space.

Application Considerations Self-Contained

Recommended Pump Location

Locate pump downstream of the cooling tower and upstream of the self-contained unit. This provides smoother and more stable unit operation.

When the tower and pump are both roof mounted, be sure to provide the necessary net positive suction head pressure to prevent cavitation. Raise the tower or submerge the pump in a sump to provide positive suction. To prevent an on-line pump failure, use a standby pump to avoid a complete system shutdown. Several partial capacity pumps or variable speed pumps may be used. Review the economics of these alternate pumping options.

Strainers and Water Treatment

Water strainers are required at the unit inlet to eliminate potential unit damage from dirty water. Specify a water basket-type strainer to avoid an incorrect stream strainer application. Untreated or poorly treated water may result in equipment damage. Consult a water treatment specialist for treatment recommendations.

Isolation Valves

Install isolation valves at each unit before the strainer and after the condenser. This allows periodic servicing of the unit or

strainer while allowing other units in the system to remain in operation.

Pressure Gauges

Install pressure gauges on the inlet and outlet of the self-contained unit. Select the gauge's scale so that the unit design operating point is approximately mid-scale.

Thermometers

Install thermometers on the condenser water inlet and outlet lines to each unit for system analysis. Trane Company recommends using a thermometer temperature range of 40 to 140 F, using a 2 F temperature increment.

Drains

The unit condensate drain is internally trapped to offset the pressure differential that exists during fan operation. Install a trapped drain in the low point of the mechanical equipment room floor to collect water from cleaning operations.

Condensing Pressure Control (Water-Cooled condensers)

Often cold condensing water applications between 35 F (1.7 C) and 54 F (12.2 C) require a condensing pressure control valve. Any unit with variable-flow waterside valves can modulate water flow to maintain a user defined condensing temperature. However, to

utilize this feature, the building water system must be capable of operating at reduced water flow rates through the self-contained units. It is imperative to install variable volume pumps or an external bypass in the water distribution system.

Waterside Economizer Flow Control

Units equipped with waterside economizer control valves can be set up for variable or constant water flow.

Use constant water flow setup on water systems that are not capable of unloading water supply to the unit. The economizer and condenser valves will operate in complement to one another to provide continuous water flow.

Use variable water flow setup with water flow systems that can take advantage of pump unloading for energy savings. Since non-cooling operation restricts water flow during part load economizing or condensing temperature control, it is imperative to install variable volume pumps or an external bypass in the water distribution system.

Unit Operating Limits

Airflow

The minimum recommended airflow for proper VAV system staging and temperature control is 35 percent of nominal design airflow. Adjusting VAV boxes with the appropriate minimum settings will prevent the self-contained unit from operating in a surge condition at airflows below this point. Continuous operation in a surge condition can cause fan failure. Reference General Data Tables on pages 17-20 for minimum airflow conditions.

Signature Series self-contained units use fixed pitch sheaves. Adjust air balancing by obtaining alternate fixed pitch sheave selections from the local Trane sales office.

Waterflow

Use 3 gpm/ton for optimum unit capacity and efficiency. Use 2.5 or 2 gpm/ton to reduce pump energy, cooling tower and piping costs. However, these reduced waterflows may impact unit capacity and efficiency by one or two percent. Consult General Data Tables on pages 17-20 for unit specific waterflow ranges.

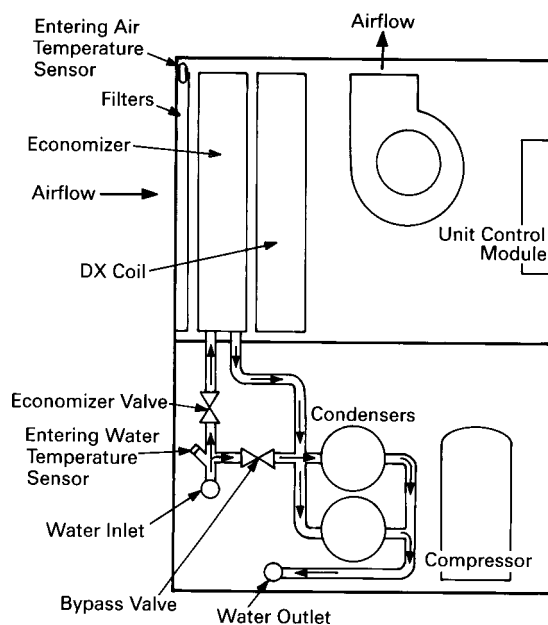

Waterside Economizer Piping

Application Considerations

Air Cooled Condenser

Remote Air-Cooled Condenser

Unit Location

Unobstructed condenser airflow is essential to maintaining capacity and operating efficiency. When determining unit placement, give careful consideration to assure sufficient airflow across the condenser coils. Avoid these two detrimental conditions: warm air recirculation and coil starvation.

Both warm air recirculation and coil starvation cause reductions in unit efficiency and capacity because of the higher head pressure associated with them. In more severe cases, nuisance unit shutdowns will result from excessive head pressures.

Clearance

Ensure vertical condenser air discharge is unobstructed. While it is difficult to predict the degree of warm air recirculation, a unit installed with a ceiling or other obstruction above it will experience a capacity reduction that will reduce the maximum ambient operation limit. Nuisance high head pressure tripouts may also occur.

The coil inlet must also be unobstructed. A unit installed closer than the minimum recommended distance to a wall or other vertical riser will experience a combination of coil starvation and warm air recirculation. This may result in unit capacity and efficiency reductions, as well as possible excessive head pressures. Reference the service clearance section on page 93 for recommended lateral distances.

Ambient Limitations

Standard ambient control allows operation down to 45 F (7.2 C) with cycling of condenser fans. Units with the low ambient option are capable of starting and operating in ambient temperatures down to 0 F (-17.8 C). Optional low ambient units use a condenser fan damper arrangement that controls condenser capacity by modulating damper airflow in response to saturated condenser temperature.

Maximum ambient temperature operation of a standard condenser is 115 F (46.1 C). Operation at design ambient above 115 F can result in excessive head pressures. For applications above 115 F, contact the local Trane sales office.



Selection Procedure

Self-Contained

Following is a sample selection for a standard applied water-cooled self-contained at particular operating conditions. Use Trane Official Product Selection System, TOPSS™, for making all final selections or contact your local Trane representative.

Unit Capacities

- 1** Determine entering air temperature dry bulb and wet bulb and entering water temperature.
- 2** Refer to the Performance Data section beginning on page 32 to find gross total and sensible capacity that best meets capacity requirements.
- 3** Apply the cfm correction factors from the capacity correction factor Table PD-1 on page 31 to determine gross total and gross sensible capacities at desired cfm.
- 4** Multiply condenser water delta T by the total capacity cfm correction factor to determine new condenser water delta T.
- 5** Using design cfm, determine static air pressure drops for accessories from the air pressure drop Charts PD-1 through PD-18. Add accessory static pressure drops to external supply and return static air pressure drops. Use the total air pressure drop to determine rpm and brake horsepower requirements from the appropriate fan curve. Note: The fan curves include refrigerant coil and internal cabinet static loses.
- 6** Calculate supply fan motor heat by using the following equation:
Fan motor heat (MBh) = 2.8 x fan motor brake horsepower
- 7** Determine net total capacity and net sensible capacity by subtracting fan motor heat from gross total capacity and gross sensible capacity.

- 8** Refer to Trane psychometric chart to determine leaving air temperatures.

Waterside Economizer Capacity

- 1** After determining that the unit will meet the required mechanical cooling capacity, determine the waterside economizer capacity by referring to the appropriate two-row (low capacity) or four-row (high capacity) waterside economizer capacity tables on pages 32-58.
- 2** Determine entering air temperature dry bulb and wet bulb, condenser water flow (gpm), and economizer entering water temperature.
- 3** Refer to the appropriate waterside economizer table to find gross total and sensible capacity and the leaving water temperature.
- 4** Apply the cfm correction factor for the waterside economizer from the appropriate table to determine the gross total and sensible capacities at the desired cfm.
- 5** Multiply the condenser water delta T by the total capacity cfm correction factor to determine the new delta T.
- 6** Calculate supply fan motor heat by using the following equation:
Fan motor heat (MBh) = 2.8 x fan motor brake horsepower
- 7** Determine net total and sensible capacity by subtracting fan motor heat from gross total and sensible capacity.
- 8** Refer to the Trane psychometric chart to determine leaving air temperatures.

Selection Procedure

Self-Contained

Selection Example

Design Conditions

Total gross capacity required =
420 MBh = 35.2 Tons
Total sensible capacity required =
315 MBh
Entering air temperature = 80/67
Entering water temperature = 85
Water flowrate = 105 gpm
Airflow = 14840 cfm at 2.5-inch
duct static pressure

Unit includes:

- Inlet guide vanes
- Waterside economizer
- Medium velocity throwaway filters

Unit Selection

Tentatively select a 35 ton unit
Model SCWF 35.
Refer to Table PD-19 on page 43 to obtain
gross total and sensible unit capacities,
and gpm at the design conditions:
Total capacity = 419.0 MBh
Sensible capacity = 309.0 MBh
Leaving water temperature = 94.7 F
Since the design cfm is greater than the
nominal cfm, adjust the capacities and
condenser water delta T to reflect the
higher cfm:
$$\frac{\text{design cfm}}{\text{nominal cfm}} = \frac{14840}{14000} = +6\% \text{ of nom. cfm}$$

Refer to Table PD-1 on page 31 to obtain
the capacity correction factors for +6% of
nominal cfm:

Cooling capacity multiplier = 1.009
Sensible capacity multiplier = 1.027

Multiply the capacities by the correction
factors:

$419 \text{ MBh} \times 1.009 = 422.8 \text{ MBh}$
 $309 \text{ MBh} \times 1.027 = 317.3 \text{ MBh}$

The SCWF 35 meets the total and
sensible design requirements.

Multiply the delta T of 9.7 F, by the cooling
capacity correction factor of 1.009 to
obtain new delta T of 9.79 and add this to
the entering water temperature to obtain
the actual leaving water temperature of
94.79 F

Determine static air pressure drops
through the accessories at the design cfm
from Chart PD-3 on page 22:

4-row waterside economizer = 0.37 in.
Medium velocity filters = 0.28 in.
add this to the 2.5 inch duct static
pressure for a total external static
pressure of 3.15 inches.

Refer to the fan curve with inlet guide
vanes, Chart PD-38 on page 43, to
determine approximate brake
horsepower and fan rpm:

Fan brake horsepower = 16 bhp
Fan rpm = 1020 rpm

Determine net capacities by subtracting
fan motor heat from gross capacities:

$2.8 \times 16 \text{ bhp} = 44.8 \text{ MBh}$
Net total capacity = 422.8 MBh -
44.8 MBh = 378.0 MBh
Net sensible capacity = 317.3 MBh -
44.8 MBh = 272.5 MBh

Determine waterside economizer
capacity by referring to Table PD-17 on
page 42. Use entering air of 80/67 and
entering water temperature of 55 deg F
at 105 gpm. The table provides a gross
total capacity of 282.1 MBh and gross
sensible capacity of 277.2 MBh and
60.4 deg F leaving water temperature at
nominal cfm.

Determine gross capacities at design cfm
by applying the cfm correction factors
from waterside economizer from Table
PD-1 on page 31. Use the following
correction factors:

$282.1 \text{ MBh} \times 1.009 = 284.6 \text{ MBh}$
 $277.2 \text{ MBh} \times 1.027 = 284.7 \text{ MBh}$

Apply the cooling correction factor to
water delta T to determine new delta T of
5.45 F

Determine net capacities by subtracting
fan motor heat for net total capacity of
239.8 MBh and net sensible capacities of
239.9 MBh.



Selection Procedure

Model Number Description

Self-Contained Model Number Description

S C W F N 20 4 2 BO A B 2 10 065 B A 1 0 1 0 A A C F A 1 1 0 T 2 0
1 2 3 4 5 6 7 8 9 10 11 12 13 14 15 16 17 18 19 20 21 22 23 24 25 26 27 28 29 30 31 32 33 34 35 36

Digit 1 - Unit Model

S = Self Contained

Digit 2 - Unit Type

C = Commercial

I = Industrial

Digit 3 - Condenser Medium

W = Water-Cooled

R = Air-Cooled

Digit 4 - Development Sequence

F = Signature Series

Digit 5 - Refrigerant Circuit Configuration

N = Independent (Water-Cooled)

M = Manifoldd (30, 35, 40, 50, 60-Ton Air-Cooled Only)

Digit 6, 7 - Unit Nominal Capacity

20 = 20 Tons (Water or Air)

22 = 22 Tons (Water Only)

25 = 25 Tons (Water or Air)

29 = 29 Tons (Water or Air)

30 = 30 Tons (Air Only)

32 = 32 Tons (Water Only)

35 = 35 Tons (Water or Air)

38 = 38 Tons (Water Only)

40 = 40 Tons (Air Only)

42 = 42 Tons (Water Only)

46 = 46 Tons (Water Only)

50 = 50 Tons (Air Only)

52 = 52 Tons (Water Only)

58 = 58 Tons (Water Only)

60 = 60 Tons (Air Only)

65 = 65 Tons (Water Only)

72 = 72 Tons (Water Only)

80 = 80 Tons (Water Only)

Digit 8 - Unit Voltage

6 = 200 Volt/60 Hz/3 ph

4 = 460 Volt/60 Hz/3 ph

5 = 575 Volt/60 Hz/3 ph

Digit 9 - Air Volume/Temp Control

1 = IGV and Supply Air Temp Ctrl

2 = VFD and Supply Air Temp Ctrl

3 = VFD w/ Bypass and Supply Air Temp Ctrl

4 = w/o Vol. CTRL, w/ Zone Temp Cool

5 = w/o Vol. CTRL, w/ Zone Temp Heat/Cool

6 = w/o Vol. CTRL and Supply Air Temp Ctrl

Digit 10, 11 - Design Sequence

BO = "B" Design

Digit 12 - Unit Construction

A = Vertical Discharge

B = Vertical Discharge with Double Wall

Digit 13 - Flexible Horizontal Discharge Plenum Type

B = Std Plenum w/ Factory Cut Holes

C = Low Plenum w/ Factory Cut Holes

E = Std Plenum w/ Field Cut Holes

F = Low Plenum w/ Field Cut Holes

H = Std Plenum Double wall w/ Field Cut Holes

J = Low Plenum Double wall w/ Field Cut Holes

K = 45" Plenum w/Factory Cut Holes, Ship Separate

L = Std Plenum w/Factory Cut Holes, Ship Separate

M = Low Plenum w/Factory Cut Holes, Ship Separate

N = 45" Plenum w/Field ut Holes, Ship Separate

P = Std Plenum w/Field Cut Holes, Ship Separate

R = Low Plenum w/Field Cut Holes, Ship Separate

T = 45" Double Wall Plenum w/Field Cut Holes, Ship Separate

U = Std Double Wall Plenum w/Field Cut Holes, Ship Separate

V = Low Double Wall Plenum w/Field Cut Holes, Ship Separate

0 = None

Digit 14 - Motor Type

1 = Std Eff. ODP Motor

2 = Premium Eff. ODP Motor

3 = Totally Enclosed Motor

Digit 15, 16 - Motor HP

05 = 5 HP Motor

07 = 7.5 HP Motor

10 = 10 HP Motor

15 = 15 HP Motor

20 = 20 HP Motor

25 = 25 HP Motor

30 = 30 HP Motor

40 = 40 HP Motor

50 = 50 HP Motor (460V & 575V Only)

Digit 17, 18, 19 - Fan RPM

040 = 400 rpm

045 = 450 rpm

050 = 500 rpm

055 = 550 rpm

060 = 600 rpm

065 = 650 rpm

070 = 700 rpm

075 = 750 rpm

080 = 800 rpm

085 = 850 rpm

090 = 900 rpm

095 = 950 rpm

100 = 1000 rpm

105 = 1050 rpm

110 = 1100 rpm

115 = 1150 rpm

120 = 1200 rpm

125 = 1250 rpm

130 = 1300 rpm

135 = 1350 rpm

140 = 1400 rpm

145 = 1450 rpm

150 = 1500 rpm

Digit 20 - Heating Type

A = Steam Coil

B = Hot Water Coil

C = Electric Heat (1 Stage)

F = Hydronic Heat Ctrl Interface

G = Elec. Heat Ctrl Interface (1 stage)

K = Steam Coil Ship Separate

L = Hot Water Coil Ship Separate

0 = Without Heat

Digit 21 - Unit Isolators

A = Isopads

B = Spring Isolators

0 = None

Digit 22 - Unit Finish

1 = Paint - Executive Beige

2 = Protective Coating

3 = Protective Coating w/ Finish Coat

Digit 23 - Future Use

0 = None

Digit 24 - Unit Connection

1 = Disconnect Switch

2 = Terminal Block

3 = Dual Point Power (2 Blocks)

Selection Procedure

Model Number Description

Self-Contained Model Number Continued –

Digit 25 - Industrial Options

A = Protective Coating Evaporator Coil
 B = Silver Solder
 C = Stainless Steel Screws
 D = A and B
 E = A and C
 F = B and C
 G = A, B, and C
 0 = None

Digit 26 - Drain Pan Type

A = Galvanized Sloped
 B = Stainless Steel Sloped

Digit 27 - Waterside Economizer

A = Mechanical Clean Full Capacity (4-row)
 B = Mechanical Clean Low Capacity (2-row)
 C = Chemical Clean Full Capacity (4-row)
 D = Chemical Clean Low Capacity (2-row)
 0 = None

Digit 28 - Ventilation Control

B = Airside Econ w/Traq™ Damper (Top O/A)
 C = Airside Econ w/ Standard Damper (Top O/A)
 E = Airside Econ w/Traq™ Damper and Comparative Enthalpy (Top O/A)
 F = Airside Econ w/ Standard Damper and Comparative Enthalpy (Top O/A)
 H = None, 2-Position Damper Ventilation Interface
 J = Airside Economizer Interface
 K = Airside Economizer Interface w/ Comparative Enthalpy

Digit 29 - Water Piping

D = Left Hand Basic Piping
 F = Left Hand Intermediate Piping
 K = Left Hand Basic w/ Flow Switch
 M = Left Hand Intermediate w/ Flow Switch
 0 = None

Digit 30 - Condenser Tube Type

A = Standard Condenser Tubes
 B = 90/10 CuNi Condenser Tubes
 0 = None (Air-cooled Only)

Digit 31 - Compressor Service Valves

1 = With Service Valves
 0 = None

Digit 32 - Miscellaneous System Control

1 = Timeclock
 2 = Interface for Remote HI (IPCB)
 3 = Dirty Filter Switch
 4 = 1 and 2
 5 = 1 and 3
 6 = 2 and 3
 7 = 1, 2 and 3
 0 = None

Digit 33 - Control Interface Options

A = Generic BAS Module (GBAS)
 B = Ventilation Override Module (VOM)
 C = Tracer Comm. Interface Module (TCI)
 D = Remote Human Interface (RHI)
 E = GBAS and TCI
 F = VOM and TCI
 G = GBAS and VOM

H = GBAS and RHI
 J = VOM and RHI
 K = TCI and RHI
 L = GBAS, VOM, and TCI
 M = GBAS, VOM, and RHI
 N = GBAS, TCI, and RHI
 P = VOM, TCI, and RHI
 R = GBAS, VOM, TCI, and RHI
 0 = None

Digit 34 - Agency

T = UL Agency Listing
 0 = None

Digit 35 - Filter Type

1 = Construction Throwaway
 2 = Med Eff. Throwaway

Digit 36 - Miscellaneous Control Option

A = Low Entering Air Temp. Protect Device (LEATPD)
 B = High Duct Temp T-Stat (Ship Separate)
 C = Plenum High Static Switch (Ship Separate)
 E = A and B
 F = A and C
 H = B and C
 L = A, B, and C
 0 = None

Self-Contained Accessory Model Number Description

P	S	W	F	S	A	1	1	0	AO
1	2	3	4	5	6	7	8	9	10 11

Digit 1 - Parts/Accessories

P = Parts/Accessories

Digit 2 - Unit Model

S = Self-Contained

Digit 3 - Shipment

W = With Unit

Digit 4 - Development Sequence

F = Signature Series
 G = Modular Series

Digit 5 - Sensors and Other Accessories

S = Sensors

Digit 6 - Sensors (Field Installed)

A = BAYSENS017 - Zone Temp Only (CV and VAV)
 B = BAYSENS013 - Zone Temp with Timed Override Button (CV and VAV)

C = BAYSENS014 - Zone Temp with Timed Override Button, Setpoint Dial (CV and VAV)
 E = BAYSENS008 - CV Zone Sensor
 F = BAYSENS010 - CV Zone Sensor with Indicator Lights
 G = BAYSENS019 - CV Programmable Night Setback Sensor
 H = BAYSENS021 - VAV Zone Sensor with Indicator Lights
 J = BAYSENS020 - VAV Programmable Night Setback Sensor
 K = Remote Sensor Kit
 L = Outside Air Temperature Sensor Kit
 M = Outside Air Humidity Sensor Kit
 0 = None

Digit 7 - Low Entering Air Temperature Protection Device (Field Installed)

1 = Low Entering Air Temperature Protection Device
 0 = None

Digit 8 - Carbon Dioxide Sensor (field installed)

1 = Carbon Dioxide Sensor Kit
 0 = None

Digit 9 - Not Used

0 = None

Digit 10, 11 - Design Sequence

A0 = A Design



Selection Procedure

Model Number Description

Remote Air-Cooled Condenser Model Number Description

<u>C</u> <u>1</u>	<u>C</u> <u>2</u>	<u>R</u> <u>3</u>	<u>C</u> <u>4</u>	<u>020</u> <u>5 6 7</u>	<u>4</u> <u>8</u>	<u>A</u> <u>9</u>	<u>AO</u> <u>10 11</u>	<u>1</u> <u>12</u>	<u>A</u> <u>13</u>	<u>0</u> <u>14</u>	<u>0</u> <u>15</u>	<u>T</u> <u>16</u>	
Digit 1 - Unit Model C = Condenser	Digit 2 - Unit Type C = Commercial I = Industrial	Digit 3 - Condenser Medium R = Remote	Digit 4 - Development Sequence C = C	Digit 5, 6, 7 - Nominal Capacity 020 = 20 Tons 029 = 29 Tons 035 = 35 Tons 040 = 40 Tons 050 = 50 Tons 060 = 60 Tons	Digit 8 - Unit Voltage 4 = 460 Volt/60 Hz/3 ph 5 = 575 Volt/60 Hz/3 ph 6 = 200 Volt/60 Hz/3 ph	Digit 9 - Control Option 0 = No Low Ambient Damper, I-Pak. A = No Low Ambient Damper, T-Stat. B = Low Ambient, I-Pak. C = Low Ambient, T-Stat.	Digit 10, 11 - Design Sequence AO = "A" Design Sequence	Digit 12 - Unit Finish 1 = Paint (Executive Beige) 2 = Protective Coating					3 = Protective Coating with Finish Coat
													Digit 13 - Coil Options A = Non-Coated Aluminum C = Protective Coating Aluminum
													Digit 14 - Unit Isolators 0 = None A = Spring Isolators B = Isopads
													Digit 15 - Panels 0 = None 1 = Louvered Panels
													Digit 16 - Agency Listing 0 = None U = With UL Listing



General Data

SCWF/SIWF 20-38 Tons

Table GD-1. SCWF/SIWF Water-Cooled Self-Contained, 20-38 Tons

Unit Size	20	22	25	29	32	35	38
Compressor Data							
Quantity	2	2	2	1/1	1/1	3	3
NominalTon/Comp	10	10	10	15/10	15/10	10	10
Circuits	2	2	2	2	2	3	3
Evaporator Coil Data							
Rows	2	2	3	2	4	3	4
Sq. Ft.	21.81	21.81	21.81	29.98	29.98	31.35	31.35
Sq. m	(2.03)	(2.03)	(2.03)	(2.79)	(2.79)	(2.91)	(2.91)
FPF	144	144	144	144	144	120	144
Condenser Data							
Minimum GPM w/o Econ	36	36	36	46	46	54	54
Minimum liters / sec. w/o Econ	(2.27)	(2.27)	(2.27)	(2.9)	(2.9)	(3.41)	(3.41)
Minimum GPM w/ Econ	41	41	41	60	60	65	65
Minimum liters / sec. w/ Econ	(2.59)	(2.59)	(2.59)	(3.79)	(3.79)	(4.1)	(4.1)
Maximum GPM	80	80	80	102	102	119	119
Maximum liters / sec.	(5.05)	(5.05)	(5.05)	(6.44)	(6.44)	(7.51)	(7.51)
Evaporator Fan Data							
Quantity	1	1	1	1	1	1	1
Size (Dia. - inches)	16.5"	16.5"	16.5"	18.25"	18.25"	20"	20"
Size (Dia. - mm)	(419.1)	(419.1)	(419.1)	(463.6)	(463.6)	(508)	(508)
Minimum HP	5	5	5	5	5	5	5
Minimum kW	(3.73)	(3.73)	(3.73)	(3.73)	(3.73)	(3.73)	(3.73)
Maximum HP	20	20	20	25	25	25	25
Maximum kW	(14.91)	(14.91)	(14.91)	(18.64)	(18.64)	(18.64)	(18.64)
Minimum Design CFM	6325	6325	6500	8700	8700	9100	9880
Minimum Design liter / sec.	(2985)	(2985)	(3068)	(4106)	(4106)	(4295)	(4663)
Maximum Design CFM	8500	9350	10625	12325	13600	14875	16150
Maximum Design liter / sec.	(4012)	(4413)	(5014)	(5817)	(6418)	(7020)	(7622)
General Data							
EER	12.9	12.6	13.4	14.1	13.6	13.3	13.4
IPLV	13.6	12.9	13.6	14.5	13.0	12.8	12.4
Refrigerant Charge - lbs. R-22							
Circuit A	24	24	24	28	30	24	25
Circuit B	24	24	24	24	25	24	25
Circuit C	-	-	-	-	-	24	25
Refrigerant Charge - kg R-22							
Circuit A	(10.9)	(10.9)	(10.9)	(12.7)	(13.6)	(10.9)	(11.3)
Circuit B	(10.9)	(10.9)	(10.9)	(10.9)	(11.3)	(10.9)	(11.3)
Circuit C	-	-	-	-	-	(10.9)	(11.3)
Capacity Steps - %	100/53/0	100/53/0	100/53/0	100/62/39/0	100/59/39/0	100/65/31/0	100/65/30/0
Filter Data							
Quantity	8	8	8	8	8	8	8
Size (inches)	20x18x2	20x18x2	20x18x2	20x18x2	20x18x2	20x18x2	20x18x2
Size (mm)	(508 X 457 X 51)	(508 X 457 X 51)	(508 X 457 X 51)	(508 X 457 X 51)	(508 X 457 X 51)	(508 X 457 X 51)	(508 X 457 X 51)
Quantity	4	4	4	4	4	4	4
Size (inches)	20x20x2	20x20x2	20x20x2	20x20x2	20x20x2	20x20x2	20x20x2
Size (mm)	(508 X 508 X 51)	(508 X 508 X 51)	(508 X 508 X 51)	(508 X 508 X 51)	(508 X 508 X 51)	(508 X 508 X 51)	(508 X 508 X 51)

Notes:

- Compressors are Trane 3D® scroll.
- EER and IPLV are rated in accordance to the ARI Standard 340/360-93. Based on 80/67 F (26.7/19.4 C) to the evaporator coil, nominal airflow and 85-95 F (29.4/35 C) condenser water.
- All units operate with R-22. Units ships with full operating charge.
- Maximum cfm limits are set to prevent moisture carryover on the evaporator coil.
- Minimum cfm limits are set to ensure stable thermal expansion valve operation at low load conditions.
- Filter sizes are for units without hot water or steam heating coils.

Table GD-2. SCWF/SIWF Refrigerant Circuits, Number of Compressors by Circuit

Unit Size	Circuit 1	2	3	4
20/22/25Ton	1-10T	1-10T		
29/32Ton	1-15T	1-10T		
35/38Ton	1-10T	1-10T	1-10T	
42/46Ton	1-15T	1-10T	1-10T	
52/58Ton	1-15T	1-15T	1-15T	
60/72Ton	1-15T	1-15T	1-15T	1-10T
80Ton	1-15T	1-15T	1-15T	1-15T

Note: This table depicts compressor location in unit, plan view from left corner.



General Data

SCWF/SIWF 42-80 Tons

Table GD-3. SCWF/SIWF Water-Cooled Self-Contained, 42-80 Tons

Unit Size	42	46	52	58	65	72	80
Compressor Data							
Quantity	2/1	2/1	3	3	3/1	3/1	4
NominalTon/Comp	10/15	10/15	15	15	15/10	15/10	15
Circuits	3	3	3	3	4	4	4
Evaporator Coil Data							
Rows	3	4	2	4	3	4	6
Sq. Ft.	38.57	38.57	49.09	49.09	49.09	49.09	49.09
Sq. m	(3.58)	(3.58)	(4.56)	(4.56)	(4.56)	(4.56)	(4.56)
FPF	144	144	144	144	144	144	144
Condenser Data							
Minium GPM w/o Econ	64	64	84	84	102	102	112
Minium liters / sec. w/o Econ	(4.04)	(4.04)	(5.3)	(5.3)	(6.43)	(6.43)	(7.07)
Minimum GPM w/ Econ	64	64	84	84	102	102	112
Minium liters / sec. w/ Econ	(4.04)	(4.04)	(5.3)	(5.3)	(6.43)	(6.43)	(7.07)
Maximum GPM	142	142	186	186	226	226	248
Maximum liters / sec.	(8.96)	(8.96)	(11.73)	(11.73)	(14.26)	(14.26)	(15.65)
Evaporator Fan Data							
Quantity	1	1	1	1	1	1	1
Size (Dia. - inches)	25"	25"	25"	25"	27.5"	27.5"	27.5"
Size (Dia. - mm)	(635)	(635)	(635)	(635)	(698.5)	(698.5)	(698.5)
Minimum HP	7.5	7.5	10	10	10	10	10
Minimum kW	(5.59)	(5.59)	(7.46)	(7.46)	(7.46)	(7.46)	(7.46)
Maximum HP	30	30	50	50	50	50	50
Maximum kW	(22.37)	(22.37)	(37.29)	(37.29)	(37.29)	(37.29)	(37.29)
Minimum Design CFM	11200	11960	14250	15080	16900	18700	20800
Minimum Design liter / sec.	(5286)	(5645)	(6725)	(7117)	(7976)	(8825)	(9817)
Maximum Design CFM	17850	19550	22100	24650	27625	29800	29800
Maximum Design liter / sec.	(8424)	(9227)	(10430)	(11634)	(13038)	(14064)	(14064)
General Data							
EER	14.1	14.2	13.1	13.5	13.1	13.0	13.0
IPLV	13.9	13.6	12.9	12.5	12.4	11.8	11.4
Refrigerant Charge - lbs. R-22							
Circuit A	28	30	28	30	28	30	32
Circuit B	24	25	28	30	28	30	32
Circuit C	24	25	28	30	28	30	32
Circuit D	-	-	-	-	24	25	32
Refrigerant Charge - kg R-22							
Circuit A	(12.7)	(13.6)	(12.7)	(13.6)	(12.7)	(13.6)	(14.5)
Circuit B	(10.9)	(11.3)	(12.7)	(13.6)	(12.7)	(13.6)	(14.5)
Circuit C	(10.9)	(11.3)	(12.7)	(13.6)	(12.7)	(13.6)	(14.5)
Circuit D	-	-	-	-	(10.9)	(11.3)	(14.5)
Capacity Steps - %	100/71/43/26/0	100/70/41/30/0	100/65/32/0	100/65/30/0	100/71/44/24/0	100/71/43/23/0	100/73/46/20/0
Filter Data							
Quantity	4	4	4	4	4	4	4
Size (inches)	16x20x2	16x20x2	16x20x2	16x20x2	16x20x2	16x20x2	16x20x2
Size (mm)	(406 X 508 X 51)	(406 X 508 X 51)	(406 X 508 X 51)	(406 X 508 X 51)	(406 X 508 X 51)	(406 X 508 X 51)	(406 X 508 X 51)
Quantity	8	8	8	8	8	8	8
Size (inches)	16x25x2	16x25x2	16x25x2	16x25x2	16x25x2	16x25x2	16x25x2
Size (mm)	(406 X 635 X 51)	(406 X 635 X 51)	(406 X 635 X 51)	(406 X 635 X 51)	(406 X 635 X 51)	(406 X 635 X 51)	(406 X 635 X 51)
Quantity	2	2	2	2	2	2	2
Size	20x20x2	20x20x2	20x20x2	20x20x2	20x20x2	20x20x2	20x20x2
Size (mm)	(508 X 508 X 51)	(508 X 508 X 51)	(508 X 508 X 51)	(508 X 508 X 51)	(508 X 508 X 51)	(508 X 508 X 51)	(508 X 508 X 51)
Quantity	4	4	4	4	4	4	4
Size	20x25x2	20x25x2	20x25x2	20x25x2	20x25x2	20x25x2	20x25x2
Size (mm)	(508 X 635 X 51)	(508 X 635 X 51)	(508 X 635 X 51)	(508 X 635 X 51)	(508 X 635 X 51)	(508 X 635 X 51)	(508 X 635 X 51)

Notes:

1. Compressors are Trane 3D® scroll.
2. EER and IPLV are rated in accordance to the ARI Standard 340/360-93. Based on 80/67 F (26.7/19.4 C) to the evaporator coil, nominal airflow and 85-95 F (29.4/35 C) condenser water.
3. All units operate with R-22. Units ships with full operating charge.
4. Maximum cfm limits are set to prevent moisture carryover on the evaporator coil.
5. Minimum cfm limits are set to ensure stable thermal expansion valve operation at low load conditions.
6. Filter sizes are for units without hot water or steam heating coils



General Data

SCRF/SIRF 20-60 Tons

Table GD-4. SCRF/SIRF Air-Cooled Self-Contained

Unit Size	20	25	29	30	35	40	50	60
Compressor Data								
Quantity	2	1/1	1/1	3	3	2/1	3	4
NominalTon/Comp	10	15/10	15/10	10	10	10/15	15	15
Circuits	2	2	2	2	2	2	2	2
Evaporator Coil Data								
Rows	3	2	4	3	4	4	4	6
Sq. Ft.	21.81	29.98	29.98	31.35	31.35	38.57	49.09	49.09
Sq. m	(2.03)	(2.79)	(2.79)	(2.91)	(2.91)	(3.58)	(4.56)	(4.56)
FPF	144	144	144	120	144	144	144	144
Evaporator Fan Data								
Quantity	1	1	1	1	1	1	1	1
Size (Dia. - inches)	16.5"	18.25"	18.25"	20"	20"	25"	25"	27.5"
Size (Dia. - mm)	(419.1)	(463.6)	(463.6)	(508)	(508)	(635)	(635)	(698.5)
Minimum HP	5	5	5	5	5	7.5	10	10
Minimum kW	(3.73)	(3.73)	(3.73)	(3.73)	(3.73)	(5.59)	(7.46)	(7.46)
Maximum HP	20	25	25	25	25	40	40	50
Maximum kW	(14.91)	(18.64)	(18.64)	(18.64)	(18.64)	(22.37)	(37.29)	(37.29)
Minimum Design CFM	6500	8700	8700	9100	9880	11960	15080	20800
Minimum Design liters / sec.	(3068)	(4106)	(4106)	(4295)	(4663)	(5645)	(7117)	(9817)
Maximum Design CFM	10625	12325	13600	14875	16150	19550	24650	29800
Maximum Design liters / sec.	(5014)	(5817)	(6418)	(7020)	(7622)	(9227)	(11634)	(14064)
General Data								
EER	10.8	10.8	10.8	11.0	11.2	11.3	10.8	9.9
IPLV	11.8	12.1	11.4	12.8	12.6	12.5	12.0	10.0
Refrigerant Charge - lbs. R-22	57.2	66.7	72	57	57.2	66.7	72	72
Refrigerant Charge - kg R-22	(25.9)	(30.3)	(32.7)	(25.9)	(25.9)	(30.3)	(32.7)	(32.7)
Capacity Steps - %	100/53/0	100/62/39/0	100/59/39/0	100/65/31/0	100/65/30/0	100/70/41/30/0	100/65/30/0	100/73/46/20/0
Filter Data								
Quantity	8	8	8	8	8	4	4	4
Size (inches)	20x18x2	20x18x2	20x18x2	20x18x2	20x18x2	16x20x2	16x20x2	16x20x2
Size (mm)	(508x457x51)	(508x457x51)	(508x457x51)	(508x457x51)	(508x457x51)	(406x508x51)	(406x508x51)	(406x508x51)
Quantity	4	4	4	4	4	8	8	8
Size (inches)	20x20x2	20x20x2	20x20x2	20x20x2	20x20x2	16x25x2	16x25x2	16x25x2
Size (mm)	(508x508x51)	(508x508x51)	(508x508x51)	(508x508x51)	(508x508x51)	(406x635x51)	(406x635x51)	(406x635x51)
Quantity						2	2	2
Size (inches)						20x20x2	20x20x2	20x20x2
Size (mm)						(508x508x51)	(508x508x51)	(508x508x51)
Quantity						4	4	4
Size (inches)						20x25x2	20x25x2	20x25x2
Size (mm)						(508x635x51)	(508x635x51)	(508x635x51)
CCRC/CIRC Unit Match	20	29	29	35	35	40	50	60

Notes:

1. Compressors are Trane 3D® scroll.
2. EER and IPLV are rated in accordance to the ARI Standard 340/360-93. Based on 80/67 F (26.7/19.4 C) to the evaporator coil, nominal airflow and 95 F (35 C) ambient.
3. All units operate with R-22. Units ships with a dry nitrogen holding charge.
4. Maximum cfm limits are set to prevent moisture carryover on the evaporator coil.
5. Minimum cfm limits are set to ensure stable thermal expansion valve operation at low load conditions.
6. Filter sizes are for units without hot water or steam heating coils

Table GD-5. SCRF/SIRF Refrigerant Circuits, Number of Compressors by Circuit

Unit Size	Circuit	
	1	2
20 Ton	1-10T	1- 10T
25/29Ton	1-15T	1-10T
30/35Ton	2-10T	1-10T
40Ton	1-10T, 1-15T	1-15T
50Ton	2-15T	1-15T
60Ton	2-15T	2-15T

Note: This table depicts compressor location in unit, plan view from left corner



General Data

CCRC/CIRC

Table GD-6. CCRC/CIRC Remote Air-Cooled Condenser

Unit Size	20	29	35	40	50	60
Gross Heat Rejection (MBH)	493	538	640	725	1040	1122
Gross Heat Rejection (kW)	(144.5)	(157.7)	(187.6)	(212.5)	(304.8)	(328.8)
Condenser Fan Data						
Number/Type	4/Prop	4/Prop	6/Prop	6/Prop	8/Prop	8/Prop
Size (inches)	26	26	26	26	26	26
Size (mm)	(660.4)	(660.4)	(660.4)	(660.4)	(660.4)	(660.4)
Fan Drive	Direct	Direct	Direct	Direct	Direct	Direct
No. of Motors/HP ea.	4/1	4/1	6/1	6/1	8/1	8/1
Nominal CFM	18,800	21,200	35,600	39,800	46,200	56,400
Nominal (liters / sec)	(8873)	(10005)	(16801)	(18784)	(21804)	(26618)
Condenser Coil Data						
Circuit 1 Size (in.)	1/46x71	1/64x71	2/46x71	2/46x71	2/64x71	2/64x71
Circuit 1 Size (mm)	(1/1168x1803)	(1/1626x1803)	(2/1168x1803)	(2/1168x1803)	(2/1626x1803)	(2/1626x1803)
Circuit 2 No./Size (in.)	1/46x71	1/46x71	1/46x71	1/64x71	1/64x71	2/64x71
Circuit 2 No./Size (mm)	(1/1168x1803)	(1/1168x1803)	(1/1168x1803)	(1/1626x1803)	(1/1626x1803)	(2/1626x1803)
Face Area (sq. ft.)	45.4	54.2	68	76.9	94.7	126.2
Face Area (sq.m)	(4.2)	(5)	(6.3)	(7.1)	(8.8)	(11.7)
Rows/fpf	4/144	4/144	4/144	4/144	4/144	4/144
Ambient Temperature Operating Range						
Standard Ambient (F)	50-115	50-115	50-115	50-115	50-115	50-115
Standard Ambient (C)	(10 - 46.1)	(10 - 46.1)	(10 - 46.1)	(10 - 46.1)	(10 - 46.1)	(10 - 46.1)
Low Ambient Option (F)	0-115	0-115	0-115	0-115	0-115	0-115
Low Ambient Option (C)	(-17.8 - 46.1)	(-17.8 - 46.1)	(-17.8 - 46.1)	(-17.8 - 46.1)	(-17.8 - 46.1)	(-17.8 - 46.1)

Notes:

- Gross Heat Rejection is at a 20 F (-6.7 C) ITD (Initial Temperature Difference) between condensing temperature and ambient air entering condenser (includes the effect of subcooling).
- Operating charge is for entire unit, including 100 feet of interconnecting piping.
- At conditions of 95 F (35 C), condenser is 95 percent full.

Table GD-7. SCRf/SIRf Air-Cooled Self-Contained and CCRC/CIRC Remote Air-Cooled Condenser

Unit Size	20	29	35	40	50	60
Refrigerant Circuit General Data						
No. of Refrigerant Circuits	2	2	2	2	2	2
Operating Charge - lbs. R-22	36/36	58/36	72/36	94/36	115/58	115/115
Operating Charge - kg R-22	(16.3/16.3)	(26.3/16.3)	(32.7/16.3)	(42.6/16.3)	(52.2/26.3)	(52.2/56.7)
Cond. Storage Cap. - lbs. R-22	44/44	61/44	88/44	105/44	122/122	122/122
Cond. Storage Cap. - kg R-22	(20/20)	(27.7/20)	(39.9/20)	(47.6/20)	(55.3/55.3)	(55.3/55.3)

Notes:

- Gross heat rejection is at a 20 F (-6.7 C) ITD (initial temperature difference) between condensing temperature and ambient air entering condenser (includes the effect of subcooling).
- Operating charge is for entire system, which includes the air-cooled self-contained, remote air-cooled condenser, and 25 feet of interconnecting refrigerant piping.
- At conditions of 95 F (35 C), condenser storage capacity is 95% full.
- To determine the correct amount of refrigerant needed for a particular application, reference the *Trane Reciprocating Refrigeration Manual*.



General Data

Heating Coil

Table GD-7. Self-Contained Heating Coil

Unit Size	SCWF 20 - 38	SCWF 42 - 80	SCRF 20 - 35	SCRF 40 - 60
Steam Coil				
Coil Type	NS	NS	NS	NS
Rows	1	1	1	1
No./Size (inches)	((2) 24x58)	((2) 30x81)	((2) 24x58)	((2) 30x81)
No./Size (mm)	((2) 609.6x1473.2)	((2) 762x2057.4)	((2) 609.6x1473.2)	((2) 762x2057.4)
FPF	42	42	42	42
Hot Water Coil				
Coil Type	WC	WC	WC	WC
Rows	1	1	1	1
No./Size (inches)	(2) 24x58	(2) 30x81	(2) 24x58	(2) 30x81
No./Size (mm)	((2) 609.6x1473.2)	((2) 762x2057.4)	((2) 609.6x1473.2)	((2) 762x2057.4)
FPF	80	80	80	80
Filter Data				
Quantity	4	4	4	4
Size (inches)	20x18x2	16x20x2	20x18x2	16x20x2
Size (mm)	(508x457x51)	(406x508x51)	(508x457x51)	(406x508x51)
Quantity	8	8	8	8
Size (inches)	20x20x2	16x25x2	20x20x2	16x25x2
Size (mm)	(508x508x51)	(406x635x51)	(508x508x51)	(406x635x51)
Quantity		2		2
Size (inches)		20x20x2		20x20x2
Size (mm)		(508x508x51)		(508x508x51)
Quantity		4		4
Size (inches)		20x25x2		20x25x2
Size (mm)		(508x635x51)		(508x635x51)

Notes:

1. Hot water and steam heating coils have Prima-Flo® fins without turbulators.
2. For coil capacities, use TOPSS™ (Trane Official Product Selection Program).
3. Full capacity coils consist of two coils stacked and piped in parallel.



Performance Data

Airside Pressure Drops

Chart PD-1. Airside Pressure Drop
SCWF/SIWF 20, 22, 25 and SCRF/SIRF 20

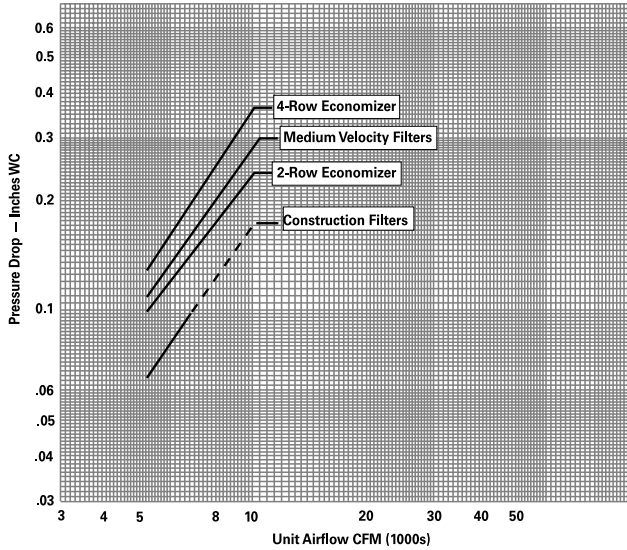

Chart PD-2. Airside Pressure Drop
SCWF/SIWF 29, 32 and SCRF/SIRF 25, 29

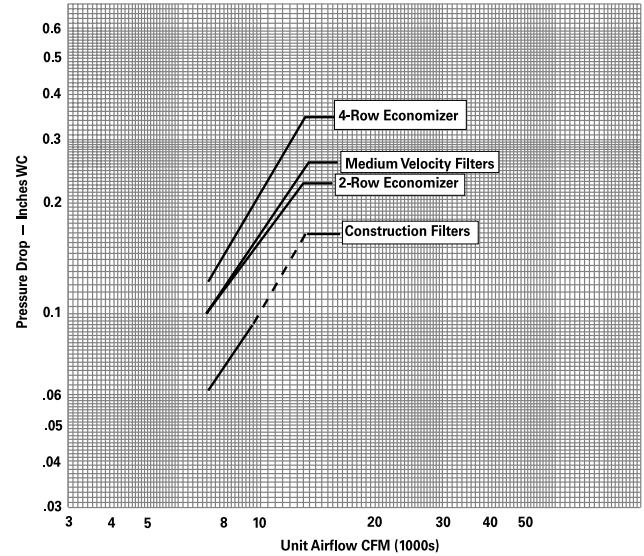

Chart PD-3. Airside Pressure Drop
SCWF/SIWF 35, 38 and SCRF/SIRF 30, 35

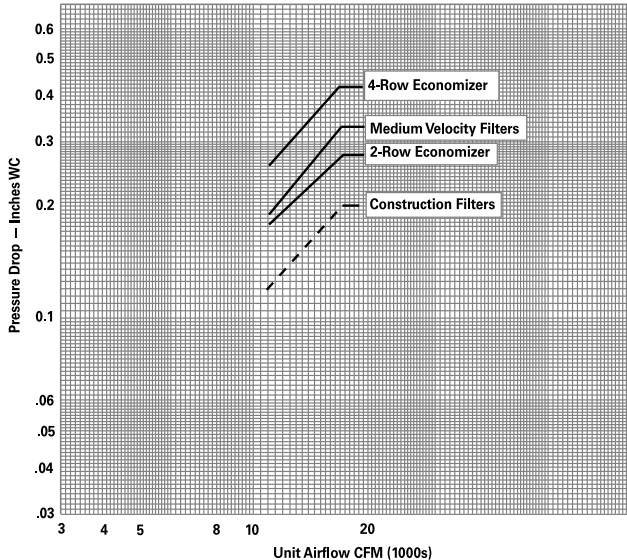
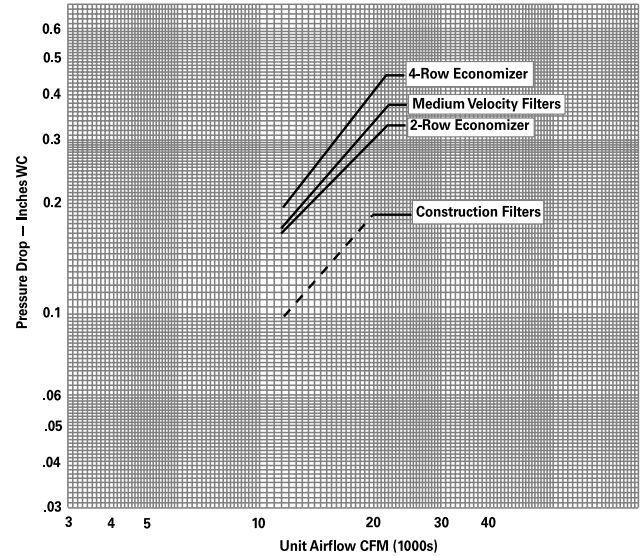

Chart PD-4. Airside Pressure Drop
SCWF/SIWF 42, 46 and SCRF/SIRF 40



- Notes:
1. Dotted line on construction filters indicates cfm where face velocity exceeds manufacturer's recommended maximum of 300 fpm. After startup, construction filters must be replaced with medium velocity or high velocity filters.
 2. Air pressure drop through electric heat is 0.5 inches WC.
 3. Refer to Page 25-26 for pressure drop through flexible horizontal discharge plenum.
 4. Refer to Page 24 for pressure drop through heating coils.

Performance Data

Airside Pressure Drops

Chart PD-5. Airside Pressure Drop
SCWF/SIWF 52, 58 and SCRF/SIRF 50

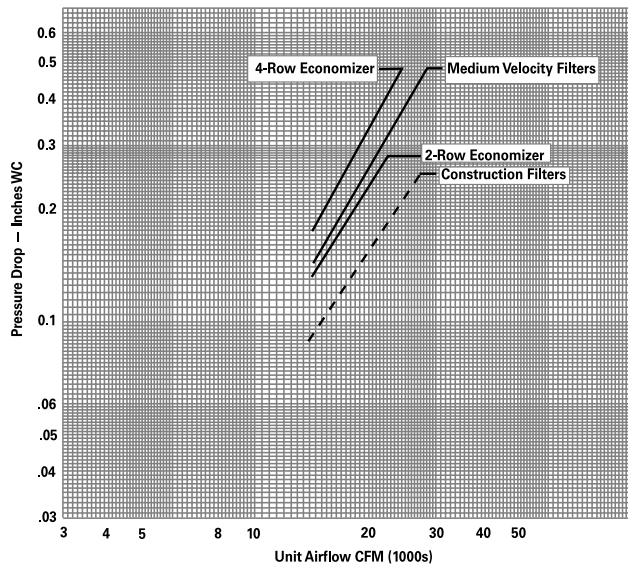

Chart PD-6. Airside Pressure Drop
SCWF/SIWF 65

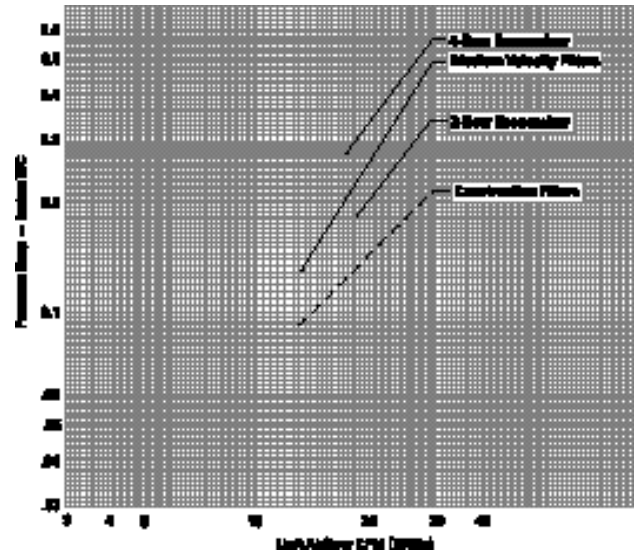

Chart PD-7. Airside Pressure Drop
SCWF/SIWF 72

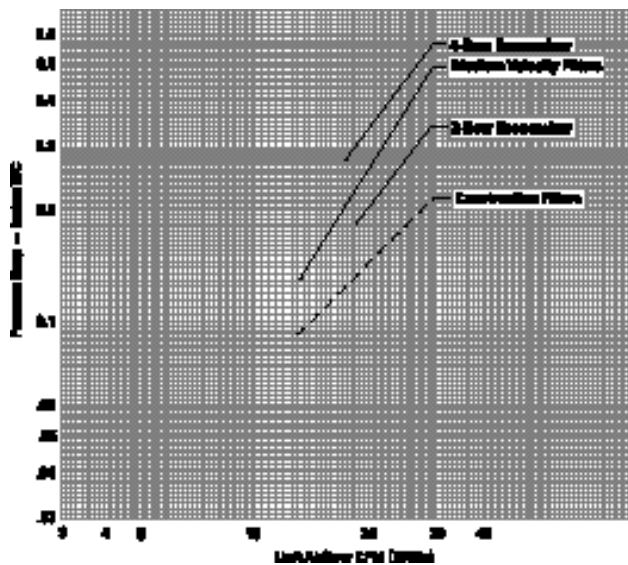
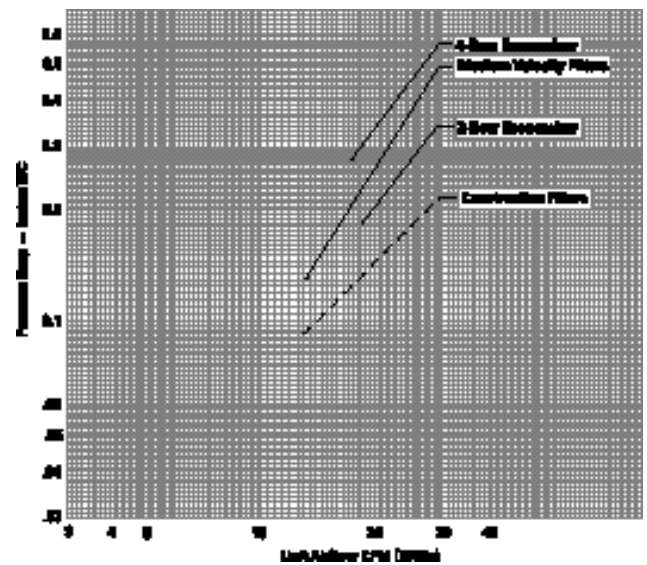

Chart PD-8. Airside Pressure Drop
SCWF/SIWF 80 and SCRF/SIRF 60



Notes:

1. Dotted line on construction filters indicates cfm where face velocity exceeds manufacturer's recommended maximum of 300 fpm. After startup, construction filters must be replaced with medium velocity or high velocity filters.
2. Air pressure drop through electric heat is 0.5 inches WC.
3. Refer to Page 25-26 for pressure drop through flexible horizontal discharge plenum.
4. Refer to Page 24 for pressure drop through heating coils.



Performance Data

Airside Pressure Drops

Heating Coils

**Chart PD-9. Airside Pressure Drop
Steam Coil
20 to 80-Ton Units**

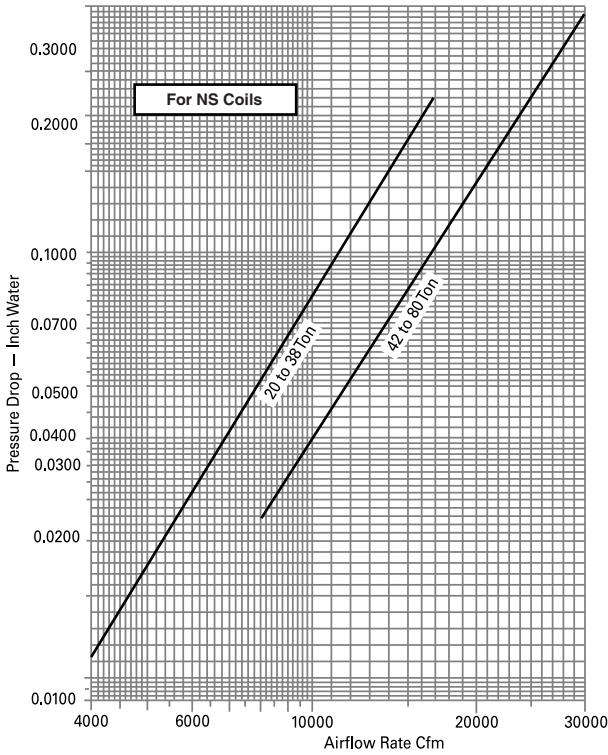

**Chart PD-10. Airside Pressure Drop
Hot Water Coil
20 to 80-Ton Units**

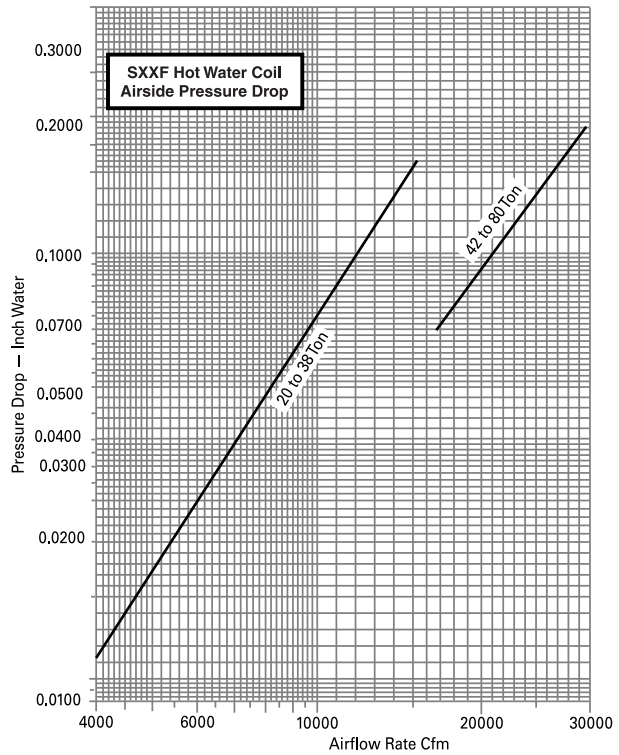

Performance Data

Airside Pressure Drops

Discharge Plenum

Chart PD-10. Airside Pressure Drop, Standard Height Discharge Plenum 20 to 38 Ton Unit

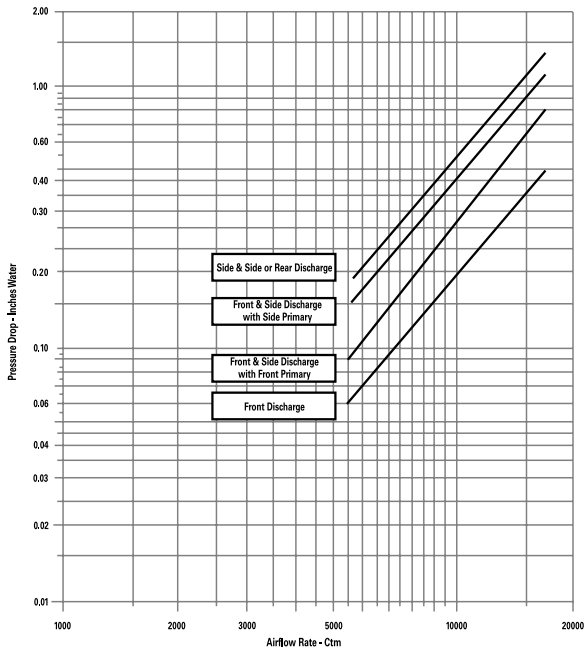

Chart PD-11. Airside Pressure Drop, Standard Height Discharge Plenum 42 to 80 Ton Unit

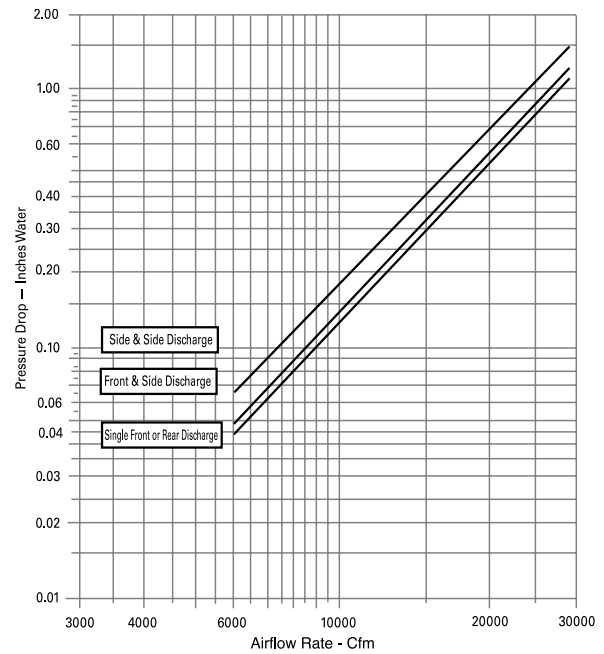

Chart PD-12. Airside Pressure Drop, Low Height Discharge Plenum 20 to 38 Ton Unit

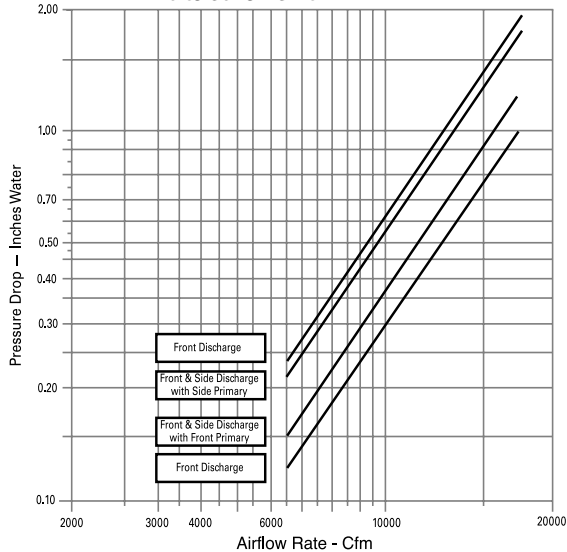
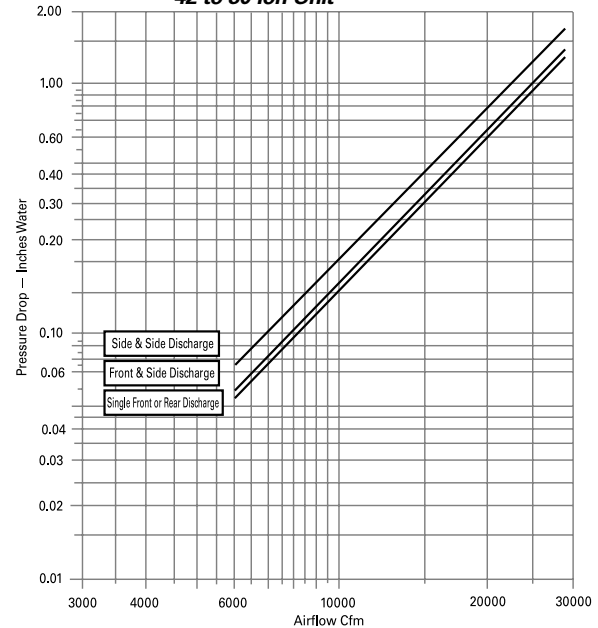

Chart PD-13. Airside Pressure Drop, Low Height Discharge Plenum 42 to 80 Ton Unit



Note:
 "Primary" refers to the side where the static pressure drop was measured. This value must be added to the unit external static pressure for proper fan horsepower determination.



Performance Data

Airside Pressure Drops

Discharge Plenum

Chart PD-14. Airside Pressure Drop
Extended Height Discharge Plenum
20 to 38-Ton Unit

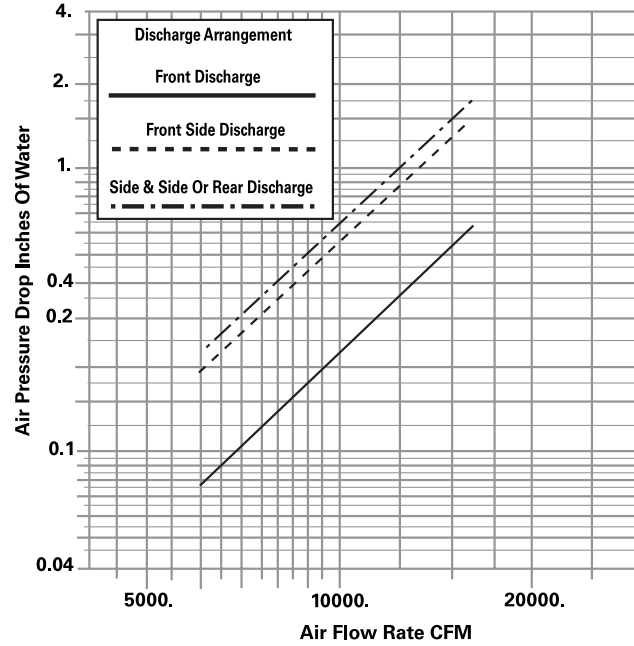
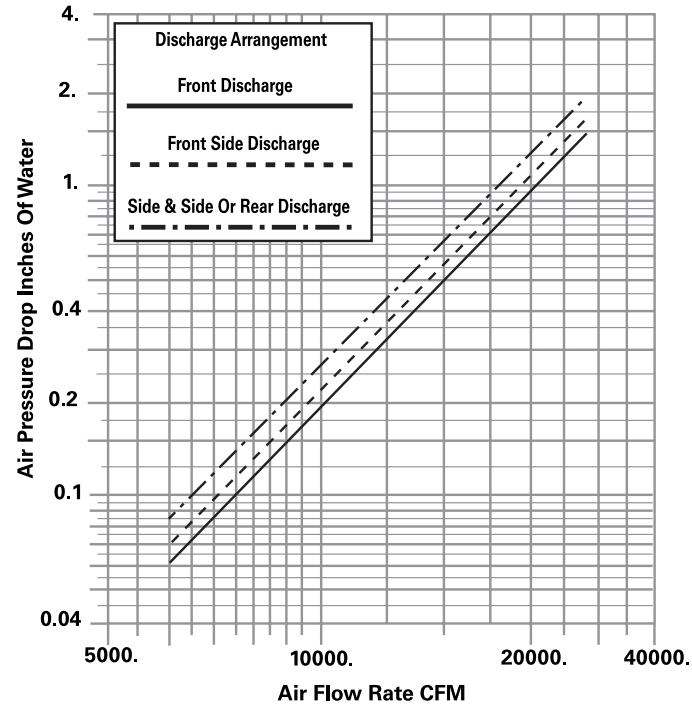

Chart PD-15. Airside Pressure Drop
Extended Height Discharge Plenum
42 to 80-Ton Unit



Performance Data

Airside Pressure Drops

Airside Economizer with Standard Damper

Chart PD-16. Airside Pressure Drop
Airside Economizer with Standard Damper
20 to 38-Ton Unit

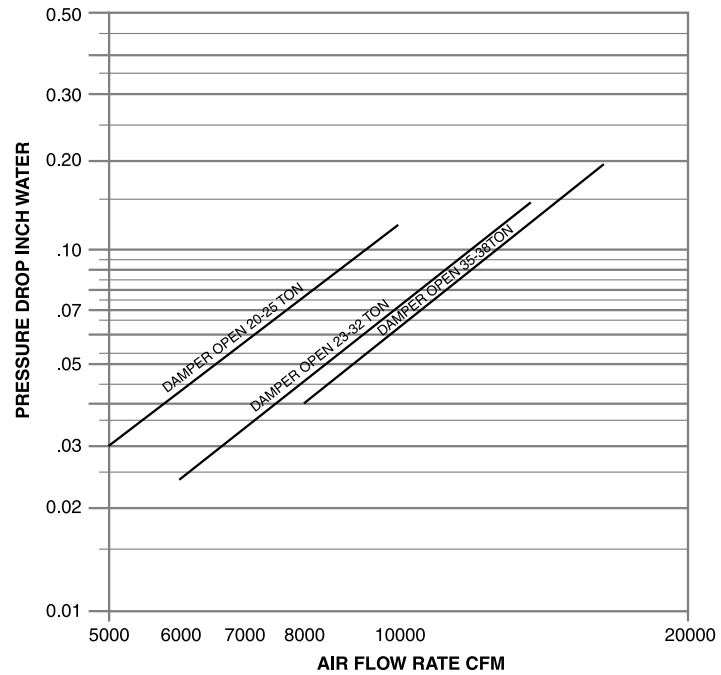
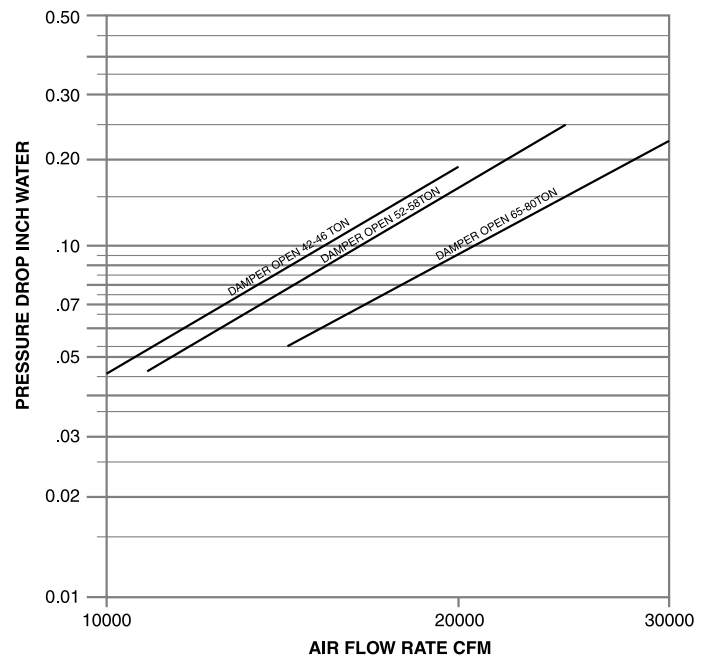

Chart PD-17. Airside Pressure Drop
Airside Economizer with Standard Damper
42 to 80-Ton Unit





Performance Data

Airside Pressure Drops

Airside Economizer with Traq™ Damper

Chart PD-18. Airside Pressure Drop
Airside Economizer with Traq™ Damper

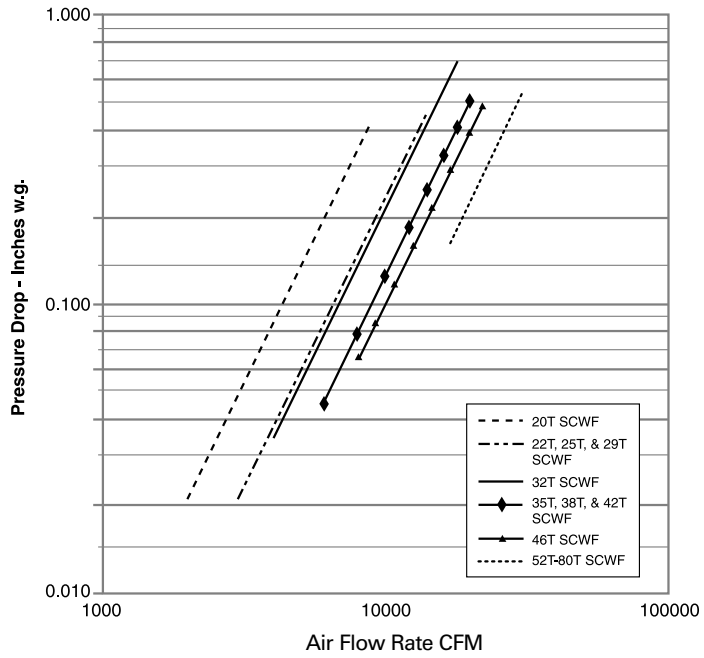

Performance Data

Waterside Pressure Drop

Chart PD-19. Waterside Pressure Drop
SCWF/SIWF 20, 22, 25

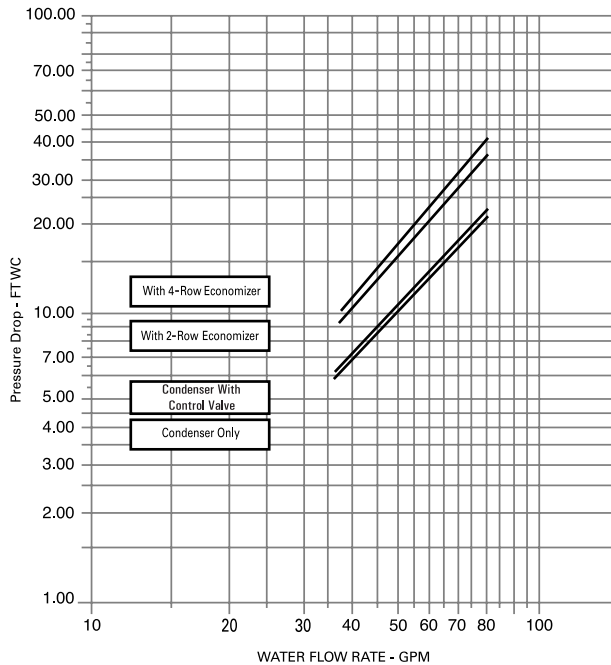

Chart PD-20. Waterside Pressure Drop
SCWF/SIWF 29, 32

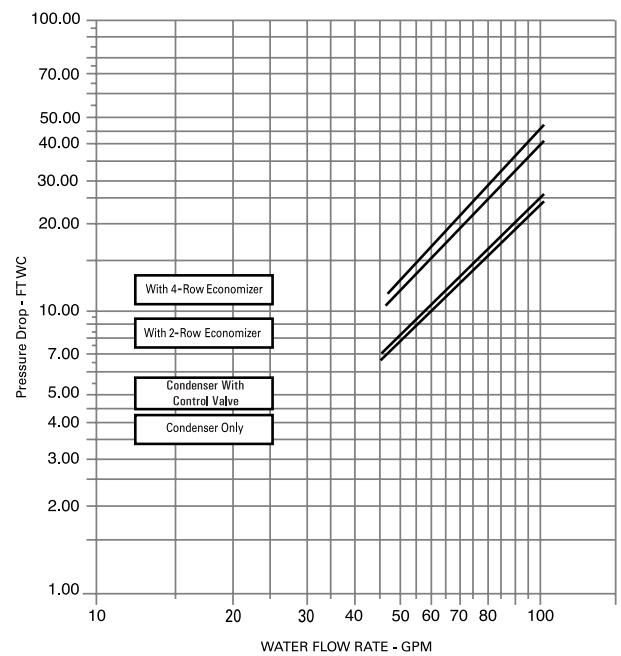

Chart PD-21. Waterside Pressure Drop
SCWF/SIWF 35, 38

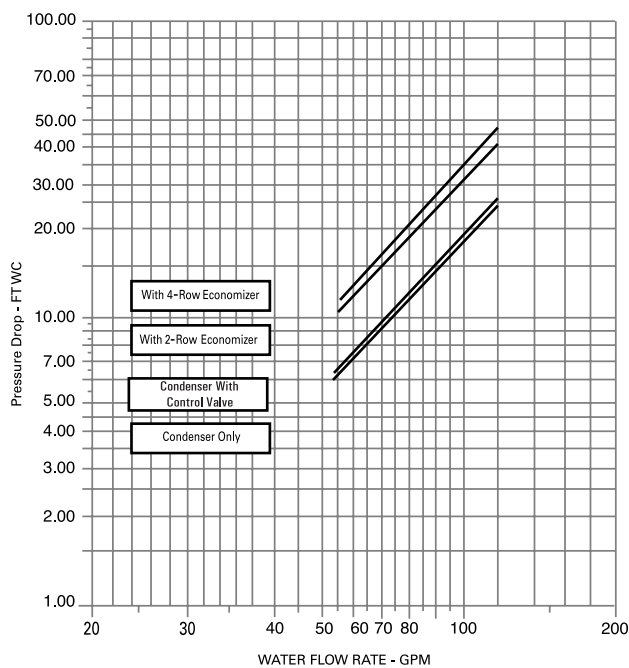
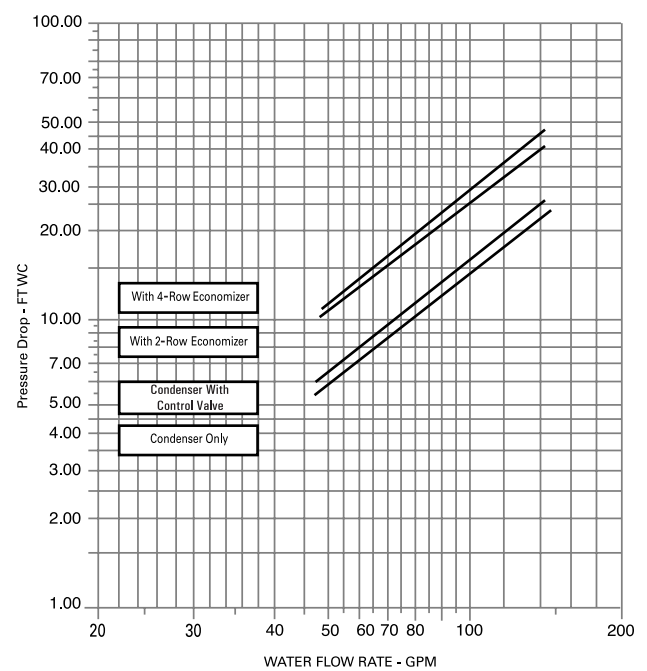

Chart PD-22. Waterside Pressure Drop
SCWF/SIWF 42, 46



Note: Each curve provides total water pressure drop through the entire unit including all accessories and internal valves and piping. Do not add curves together.



Performance Data

Waterside Pressure Drop

Chart PD-23. Waterside Pressure Drop
SCWF/SIWF 52, 58

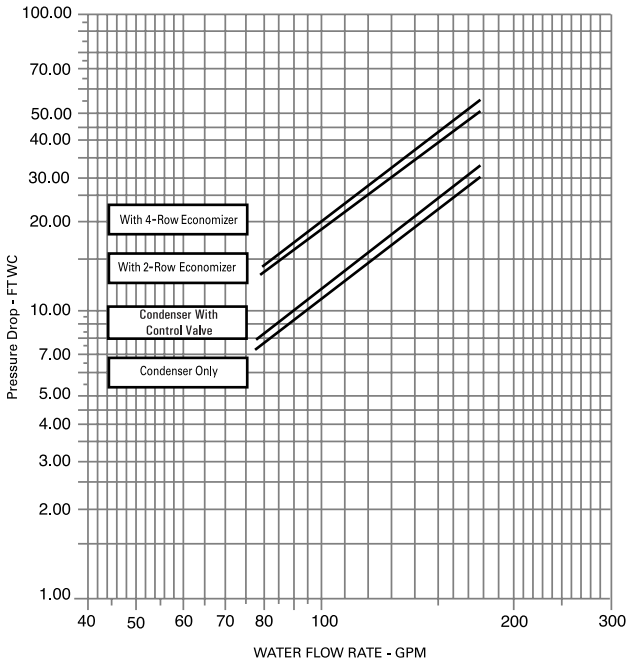

Chart PD-24. Waterside Pressure Drop
SCWF/SIWF 65

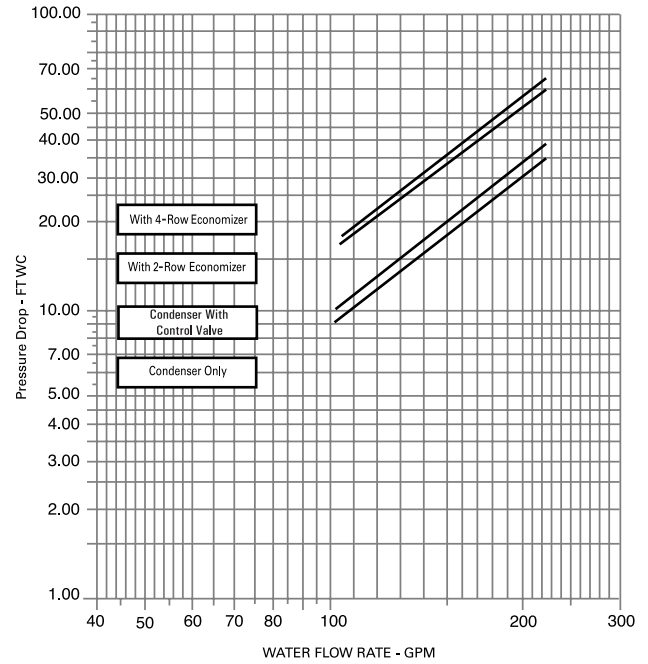

Chart PD-25. Waterside Pressure Drop
SCWF/SIWF 72

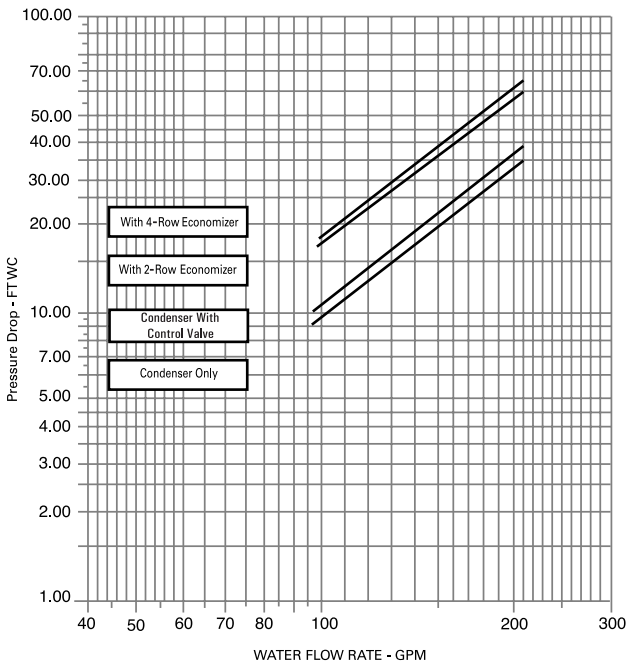
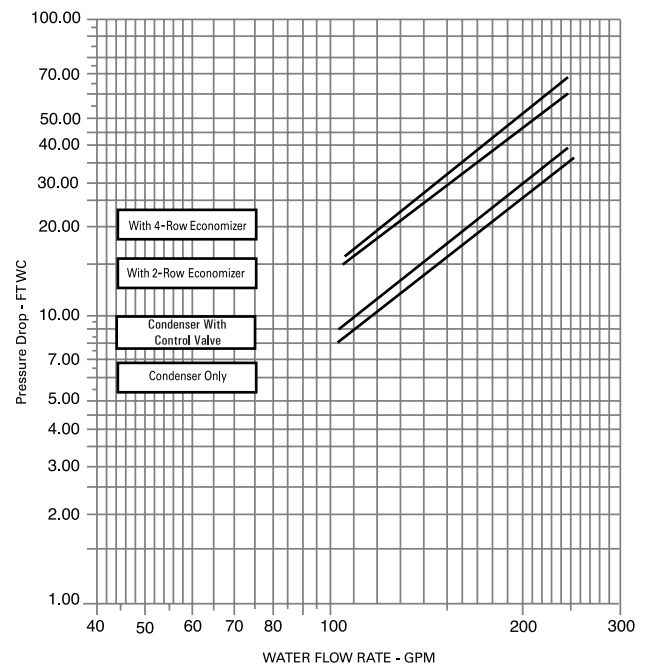

Chart PD-26. Waterside Pressure Drop
SCWF/SIWF 80



Note: Each curve provides total water pressure drop through the entire unit including all accessories and internal valves and piping. Do not add curves together.

Performance Data

Table PD-1. CFM Capacity Correction Table

	Cfm Compared To Rated Quantity	Cooling Capacity Multiplier	Sensible Capacity Multiplier
DX Cooling	-20%	0.970	0.910
	-10%	0.985	0.955
	Std	1.000	1.000
	+3%	1.005	1.014
	+6%	1.009	1.027
Waterside Economizer	-20%	0.970	0.910
	-10%	0.985	0.955
	Std	1.000	1.000
	+3%	1.005	1.014
	+6%	1.009	1.027



Performance Data

Water-Cooled 20 Ton

Table PD-2. SCWF/SIWF 20 - Economizer Full Capacity - 8,000 cfm

Entering Air		Entering Water Temp						
EDB F	EWB F	45 F			55 F			
		Flow gpm	Total MBh	Sensible MBh	LWT F	Total MBh	Sensible MBh	LWT F
	62	50	210.3	189.3	53.4	132.5	132.5	60.3
		60	220.8	193.7	52.4	136.2	136.2	59.5
		70	228.8	197.1	51.5	138.9	138.9	59.0
75	67	50	265.7	160.4	55.6	155.2	119.1	61.2
		60	284.6	167.9	54.5	164.4	122.4	60.5
		70	299.0	173.7	53.5	171.8	125.0	59.9
	72	50	339.2	133.9	58.6	221.4	92.8	63.9
		60	364.8	143.3	57.2	238.3	98.5	62.9
		70	383.9	150.5	56.0	251.4	103.0	62.2
80	62	50	230.9	226.2	54.2	165.6	165.6	61.6
		60	239.2	234.5	53.0	170.2	170.2	60.7
		70	245.2	240.6	52.0	173.5	173.5	60.0
	67	50	271.3	204.6	55.9	171.1	166.8	61.8
		60	288.1	211.3	54.6	178.2	169.4	60.9
		70	300.9	216.5	53.6	183.7	171.4	60.2
	72	50	338.5	176.3	58.5	222.0	135.4	63.9
		60	363.9	185.8	57.1	238.0	140.8	62.9
		70	383.0	193.1	55.9	250.6	145.1	62.2
85	62	50	262.5	262.5	55.5	198.6	198.6	62.9
		60	270.4	270.4	54.0	204.1	204.1	61.8
		70	275.9	275.9	52.9	208.0	208.0	60.9
	67	50	283.5	251.3	56.3	199.2	199.2	63.0
		60	298.0	257.1	54.9	204.8	204.8	61.8
		70	309.0	261.6	53.8	208.8	208.8	61.0
	72	50	340.7	219.3	58.6	230.6	180.5	64.2
		60	364.4	228.2	57.1	244.2	185.1	63.1
		70	382.6	235.1	55.9	255.1	188.8	62.3

Table PD-3. SCWF/SIWF 20 - Economizer Low Capacity - 8,000 cfm

Entering Air		Entering Water Temp						
EDB F	EWB F	45 F			55 F			
		Flow gpm	Total MBh	Sensible MBh	LWT F	Total MBh	Sensible MBh	LWT F
	62	50	140.0	135.3	50.6	92.8	92.8	58.7
		60	147.0	144.0	49.9	96.1	96.1	58.2
		70	152.4	146.2	49.4	98.4	98.4	57.8
75	67	50	175.6	114.8	52.0	102.0	88.3	59.1
		60	188.4	119.7	51.3	107.8	90.3	58.6
		70	198.0	123.3	50.7	112.6	92.0	58.2
	72	50	224.3	90.6	54.0	146.7	64.5	60.9
		60	241.1	96.5	53.0	157.3	68.0	60.2
		70	253.7	101.0	52.2	165.5	70.7	59.7
80	62	50	160.2	160.2	51.4	116.1	116.1	59.6
		60	166.4	166.4	50.5	120.1	120.1	59.0
		70	170.7	170.7	49.9	123.0	123.0	58.5
	67	50	177.8	149.8	52.1	116.4	111.3	59.7
		60	189.3	154.2	51.3	120.8	115.7	59.0
		70	198.1	157.5	50.7	124.2	119.1	58.5
	72	50	223.8	124.8	54.0	146.2	98.8	60.8
		60	240.5	130.7	53.0	156.8	102.2	60.2
		70	253.1	135.2	52.2	165.0	104.8	59.7
85	62	50	183.2	183.2	52.3	139.3	139.3	60.6
		60	190.2	190.2	51.3	144.1	144.1	59.8
		70	195.1	195.1	50.6	147.6	147.6	59.2
	67	50	188.1	187.8	52.5	139.6	139.6	60.6
		60	197.7	191.4	51.6	144.4	144.4	59.8
		70	205.0	194.3	50.9	147.9	147.9	59.2
	72	50	223.6	158.9	53.9	151.1	134.6	61.0
		60	240.0	164.7	53.0	159.8	137.4	60.3
		70	252.6	169.2	52.2	166.7	139.7	59.8



Performance Data

Water-Cooled 20 Ton

Table PD-4. SCWF/SIWF 20 Gross Cooling Capacity - 8,000 cfm, 60 gpm

Entering Air		Entering Water Temp								
EDB F	EWB F	75 F			85 F			95 F		
		Total MBh	Sensible MBh	LWT	Total MBh	Sensible MBh	LWT	Total MBh	Sensible MBh	LWT
75	62	244	185	84.7	235	181	94.7	225	176	104.6
	67	266	150	85.5	256	146	95.4	246	141	105.3
	72	289	114	86.3	278	110	96.2	267	106	106.0
80	62	244	218	84.7	235	214	94.7	226	209	104.6
	67	266	183	85.5	256	179	95.4	245	174	105.3
	72	289	147	86.3	278	143	96.1	267	139	106.0
85	62	247	246	84.8	239	239	94.8	231	231	104.8
	67	265	216	85.5	256	211	95.4	245	207	105.3
	72	288	180	86.3	278	176	96.1	267	171	106.0

Chart PD-27. SCWF/SIWF 20 Fan Performance for CV or with VFD

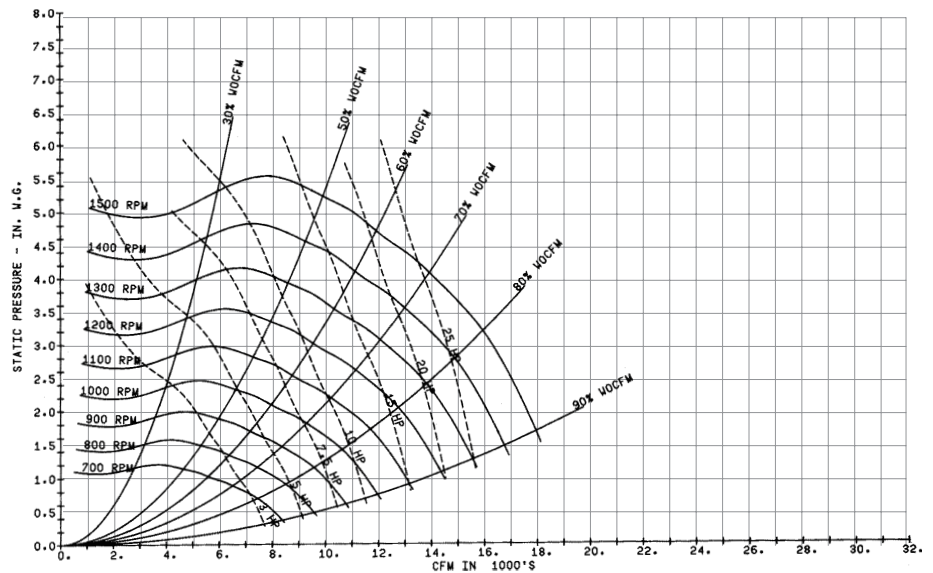
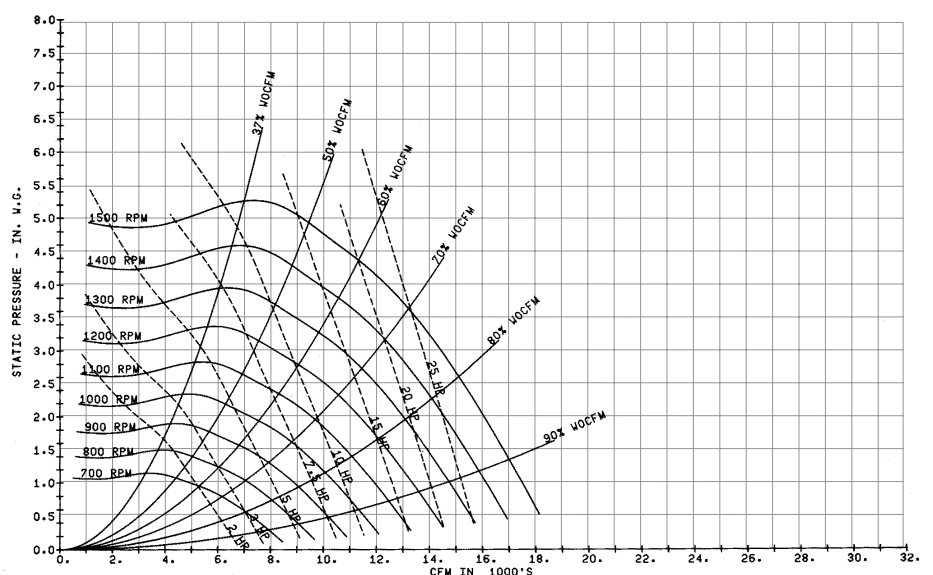

Chart PD-28. SCWF/SIWF 20 Fan Performance with Inlet Guide Vanes



Note:

1. Fan curves include refrigerant coil and internal cabinet static losses. To determine static pressure to be used with these curves, add filter, economizer, flexible horizontal discharge and heat pressure drops to external duct static pressure.



Performance Data

Water-Cooled 22 Ton

Table PD-5. SCWF/SIWF 22 - Economizer Full Capacity - 8,800 cfm

Entering Air		Entering Water Temp							
		45 F				55 F			
EDB F	EWB F	Flow gpm	Total MBh	Sensible MBh	LWT F	Total MBh	Sensible F	LWT	
	62	55	226.8	205.7	53.2	143.3	143.3	60.2	
		66	237.6	210.2	52.2	147.3	147.3	59.5	
		77	245.9	213.8	51.4	150.2	150.2	58.9	
75	67	55	286.3	173.7	55.4	167.0	129.3	61.1	
		66	305.8	181.4	54.3	176.4	132.6	60.3	
		77	320.8	187.5	53.3	184.2	135.4	59.8	
	72	55	365.5	144.5	58.3	238.0	100.2	63.7	
		66	391.8	154.1	56.9	255.6	106.1	62.7	
		77	411.9	161.6	55.7	269.5	110.8	62.0	
80	62	55	249.7	244.6	54.1	179.1	179.1	61.5	
		66	258.1	253.0	52.8	184.0	184.0	60.6	
		77	264.5	259.4	51.9	187.6	187.6	59.9	
	67	55	292.3	222.0	55.6	184.5	181.5	61.7	
		66	309.6	228.8	54.4	191.8	184.1	60.8	
		77	322.9	234.2	53.4	197.6	186.2	60.1	
	72	55	364.6	190.8	58.3	238.6	146.7	63.7	
		66	390.8	200.5	56.8	255.2	152.2	62.7	
		77	410.9	208.1	55.7	268.6	156.8	62.0	
85	62	55	284.2	284.2	55.3	214.8	214.8	62.8	
		66	292.5	292.5	53.9	220.7	220.7	61.7	
		77	298.4	298.4	52.7	225.0	225.0	60.8	
	67	55	305.7	273.1	56.1	215.5	215.5	62.8	
		66	320.5	279.0	54.7	221.4	221.4	61.7	
		77	332.0	283.6	53.6	225.8	225.8	60.9	
	72	55	366.9	237.7	58.3	247.9	195.9	64.0	
		66	391.3	246.8	56.9	262.1	200.7	62.9	
		77	410.3	254.0	55.7	273.5	204.6	62.1	

Table PD-6. SCWF/SIWF 22 - Economizer Low Capacity - 8,800 cfm

Entering Air		Entering Water Temp						
		45 F				55 F		
EDB F	EWB F	Flow gpm	Total MBh	Sensible MBh	LWT F	Total MBh	Sensible MBh	LWT F
	62	55	150.1	145.0	50.5	99.6	99.6	58.6
		66	157.1	155.1	49.8	102.9	102.9	58.1
		77	162.5	157.3	49.2	105.4	105.4	57.7
75	67	55	188.1	123.5	51.8	108.9	95.1	59.0
		66	200.9	128.4	51.1	114.8	97.1	58.5
		77	210.7	132.1	50.5	119.7	98.9	58.1
	72	55	240.1	97.1	53.7	156.6	69.2	60.7
		66	256.9	103.0	52.8	167.3	72.6	60.1
		77	269.8	107.6	52.0	175.9	75.4	59.6
80	62	55	172.2	172.2	51.3	124.5	124.5	59.5
		66	178.4	178.4	50.4	128.6	128.6	58.9
		77	182.9	182.9	49.7	131.7	131.7	58.4
	67	55	190.4	161.4	51.9	124.8	119.3	59.5
		66	201.9	165.8	51.1	129.2	123.7	58.9
		77	210.8	169.2	50.5	132.7	127.1	58.4
	72	55	239.6	134.1	53.7	156.1	106.2	60.7
		66	256.4	140.0	52.8	166.8	109.7	60.1
		77	269.2	144.6	52.0	175.3	112.4	59.6
85	62	55	196.8	196.8	52.2	149.5	149.5	60.4
		66	203.9	203.9	51.2	154.4	154.4	59.7
		77	209.0	209.0	50.4	158.1	158.1	59.1
	67	55	201.6	195.7	52.3	149.7	149.7	60.4
		66	211.1	206.2	51.4	154.7	154.7	59.7
		77	218.5	209.0	50.7	158.4	158.4	59.1
	72	55	239.3	171.1	53.7	161.4	145.1	60.9
		66	255.8	177.0	52.8	170.1	147.9	60.2
		77	268.6	181.5	52.0	177.3	150.2	59.6

Performance Data

Water-Cooled 22 Ton

Table PD-7 – SCWF/SIWF 22 Gross Cooling Capacity - 8,800 cfm, 66 gpm

Entering Air		Entering Water Temp								
		75 F			85 F			95 F		
EDB F	EWB F	Total MBh	Sensible MBh	LWT	Total MBh	Sensible MBh	LWT	Total MBh	Sensible MBh	LWT
75	62	257	197	84.3	248	193	94.3	238	188	104.2
	67	280	159	85.0	270	155	94.9	259	150	104.9
	72	305	120	85.8	294	116	95.7	282	112	105.6
80	62	257	233	84.3	248	228	94.3	238	223	104.2
	67	280	194	85.0	270	190	94.9	259	186	104.9
	72	304	156	85.8	294	152	95.7	282	147	105.6
85	62	262	261	84.4	254	254	94.4	246	246	104.4
	67	280	230	85.0	270	226	94.9	259	221	104.8
	72	304	191	85.8	293	187	95.7	282	183	105.6

Chart PD-29 – SCWF/SIWF 22 Fan Performance for CV or with VFD

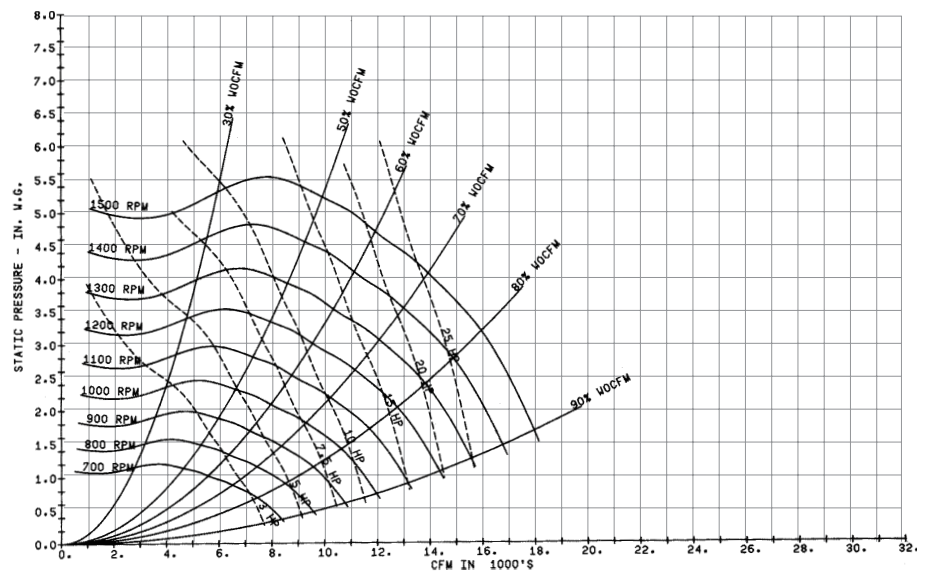
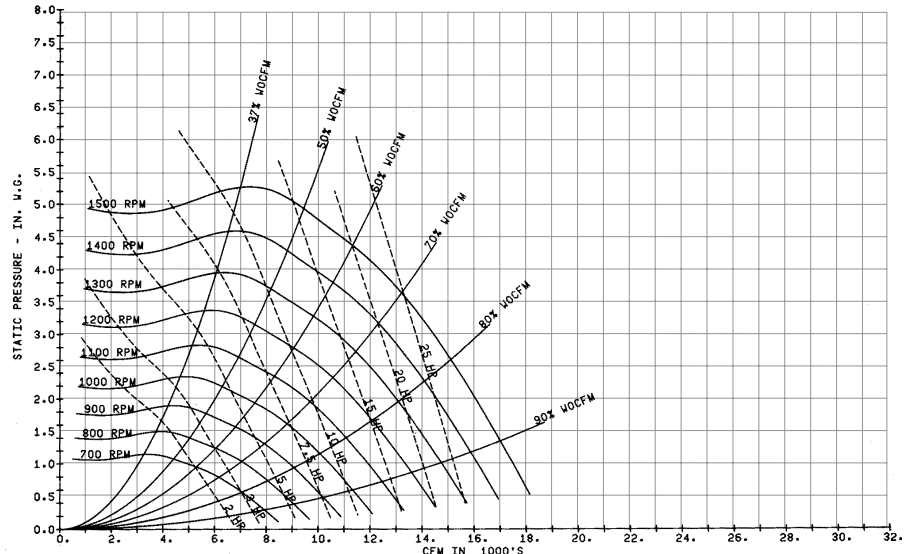

Chart PD-30 – SCWF/SIWF 22 Fan Performance with Inlet Guide Vanes



Note:

1. Fan curves include refrigerant coil and internal cabinet static losses. To determine static pressure to be used with these curves, add filter, economizer, flexible horizontal discharge and heat pressure drops to external duct static pressure.



Performance Data

Water-Cooled 25 Ton

Table PD-8. SCWF/SIWF 25 - Economizer Full Capacity - 10,000 cfm

Entering Air		Entering Water Temp						
EDB F	EWB F	Flow gpm	45 F			55 F		
			Total MBh	Sensible MBh	LWT F	Total MBh	Sensible MBh	LWT F
	62	63	250.7	229.6	53.0	159.0	159.0	60.0
		75	261.4	234.1	52.0	163.2	163.2	59.4
		80	265.2	235.7	51.6	164.6	164.6	59.1
75	67	63	316.1	193.1	55.0	183.8	144.0	60.8
		75	335.6	200.8	53.9	193.5	147.5	60.2
		80	342.5	203.6	53.6	197.0	148.7	59.9
72		63	404.1	160.2	57.8	262.3	110.9	63.3
		75	429.9	169.5	56.5	280.2	116.9	62.5
		80	439.1	172.9	56.0	286.5	119.0	62.2
62		63	276.9	271.1	53.8	198.7	198.7	61.3
		75	285.3	279.5	52.6	203.9	203.9	60.4
		80	288.2	282.4	52.2	205.6	205.6	60.1
80	67	63	322.6	247.4	55.2	203.9	202.9	61.5
		75	339.8	254.2	54.1	211.3	205.6	60.6
		80	345.9	256.6	53.6	213.9	206.5	60.3
72		63	403.2	212.1	57.8	262.8	163.2	63.3
		75	428.9	221.6	56.4	279.7	168.8	62.5
		80	438.1	225.0	56.0	285.8	170.9	62.1
62		63	315.6	315.6	55.0	238.3	238.3	62.6
		75	324.1	324.1	53.6	244.6	244.6	61.5
		80	326.9	326.9	53.2	246.6	246.6	61.2
85	67	63	337.7	304.9	55.7	239.1	239.1	62.6
		75	352.4	310.7	54.4	245.3	245.3	61.5
		80	357.6	312.8	53.9	247.4	247.4	61.2
72		63	404.8	264.6	57.9	273.0	218.6	63.7
		75	429.2	273.6	56.4	287.4	223.4	62.7
		80	438.0	276.9	55.9	292.5	225.1	62.3

Table PD-9. SCWF/SIWF 25 - Economizer Low Capacity - 10,000 cfm

Entering Air		Entering Water Temp						
EDB F	EWB F	Flow gpm	45 F			55 F		
			Total MBh	Sensible MBh	LWT F	Total MBh	Sensible MBh	LWT F
	62	63	164.5	158.7	50.2	109.2	109.2	58.5
		75	171.1	170.9	49.6	112.6	112.6	58.0
		80	173.5	171.9	49.3	113.7	113.7	57.8
75	67	63	205.7	136.0	51.5	118.7	104.8	58.8
		75	218.1	140.7	50.8	124.5	106.8	58.3
		80	222.4	142.3	50.6	126.7	107.6	58.2
72		63	262.5	106.4	53.3	170.7	75.8	60.4
		75	278.7	112.1	52.4	181.4	79.2	59.8
		80	284.5	114.1	52.1	185.2	80.4	59.6
62		63	189.1	189.1	51.0	136.5	136.5	59.3
		75	195.2	195.2	50.2	140.7	140.7	58.8
		80	197.2	197.2	49.9	142.2	142.2	58.6
80	67	63	208.1	178.0	51.6	136.8	136.8	59.3
		75	219.1	182.2	50.8	141.1	134.8	58.8
		80	223.1	183.7	50.6	142.6	136.4	58.6
72		63	262.0	147.5	53.3	170.2	116.9	60.4
		75	278.1	153.2	52.4	180.8	120.4	59.8
		80	283.9	155.2	52.1	184.6	121.6	59.6
62		63	216.2	216.2	51.9	163.9	163.9	60.2
		75	223.0	223.0	50.9	168.9	168.9	59.5
		80	225.4	225.4	50.6	170.6	170.6	59.3
85	67	63	220.7	214.1	52.0	164.2	164.2	60.2
		75	229.7	227.2	51.1	169.2	169.2	59.5
		80	233.0	228.4	50.8	170.9	170.9	59.3
72		63	261.5	188.6	53.3	175.9	160.0	60.6
		75	277.6	194.2	52.4	184.5	162.8	59.9
		80	283.2	196.2	52.1	187.7	163.8	59.7



Performance Data

Water-Cooled 25 Ton

Table PD-10. SCWF/SIWF 25 Gross Cooling Capacity - 10,000 cfm, 75 gpm

Entering Air		Entering Water Temp								
		75 F			85 F			95 F		
EDB F	EWB F	Total MBh	Sensible MBh	LWT	Total MBh	Sensible MBh	LWT	Total MBh	Sensible MBh	LWT
75	62	281	234	83.9	270	229	93.8	259	224	103.6
	67	306	184	84.5	294	179	94.4	281	174	104.3
	72	332	133	85.3	319	129	95.1	305	124	105.0
80	62	284	278	83.9	274	272	93.8	263	263	103.8
	67	306	231	84.5	294	227	94.4	281	221	104.3
	72	332	180	85.3	319	176	95.1	305	171	104.9
85	62	298	298	84.3	288	288	94.3	278	278	104.2
	67	306	278	84.6	295	272	94.4	283	267	104.3
	72	332	228	85.2	319	223	95.1	305	218	104.9

Chart PD-31. SCWF/SIWF 25 Fan Performance for CV or with VFD

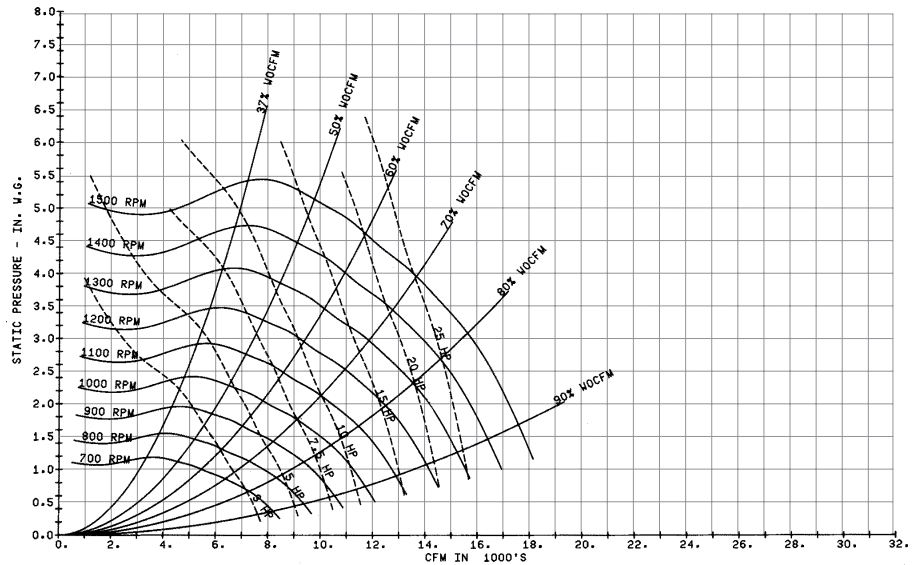
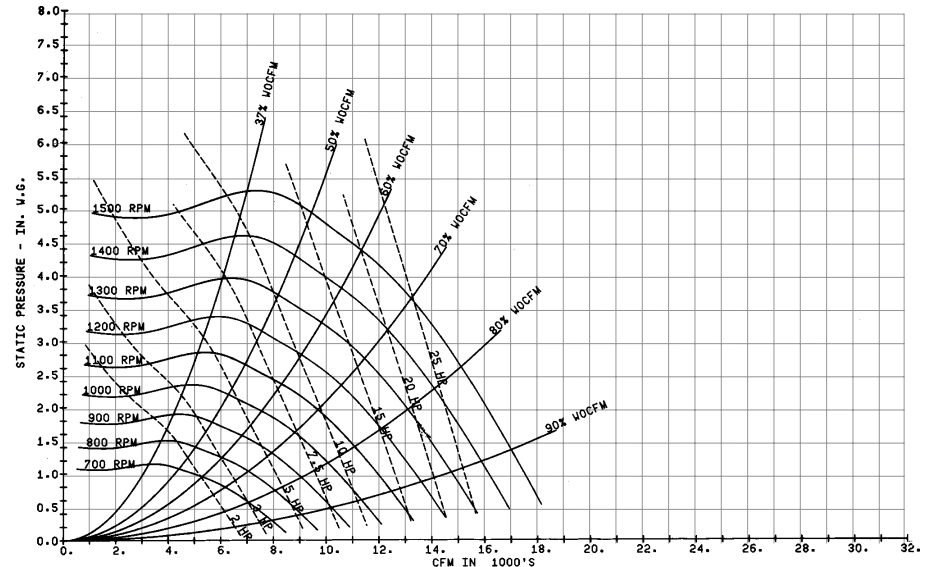

Chart PD-32. SCWF/SIWF 25 Fan Performance with Inlet Guide Vanes



Note:

1. Fan curves include refrigerant coil and internal cabinet static losses. To determine static pressure to be used with these curves, add filter, economizer, flexible horizontal discharge and heat pressure drops to external duct static pressure.



Performance Data

Water-Cooled 29 Ton

Table PD-11. SCWF/SIWF 29 - Economizer Full Capacity - 11,600 cfm

Entering Air		Entering Water Temp						
EDB F	EWB F	Flow gpm	Total MBh	45 F			55 F	
				Sensible MBh	LWT F	Total MBh	Sensible MBh	LWT F
	62	73	302.2	272.9	53.3	190.6	190.6	60.2
		87	316.4	278.8	52.3	195.7	195.7	59.5
		102	327.9	283.8	51.4	199.7	199.7	58.9
75	67	73	382.0	231.0	55.5	222.7	171.6	61.1
		87	407.4	241.1	54.4	235.2	176.0	60.4
		102	428.3	249.5	53.4	245.9	179.8	59.8
	72	73	488.3	192.9	58.4	318.0	133.5	63.7
		87	522.1	205.3	57.0	340.8	141.2	62.8
		102	549.9	215.7	55.8	360.0	147.7	62.1
	62	73	332.2	325.4	54.1	238.2	238.2	61.5
		87	343.2	336.5	52.9	244.5	244.5	60.6
		102	352.0	345.3	51.9	249.4	249.4	59.9
80	67	73	389.9	294.8	55.7	245.9	240.6	61.7
		87	412.4	303.8	54.5	255.3	244.0	60.9
		102	431.0	311.3	53.5	263.4	246.9	60.2
	72	73	487.3	254.1	58.4	318.8	195.0	63.7
		87	520.9	266.7	57.0	340.3	202.2	62.8
		102	548.6	277.2	55.8	358.8	208.5	62.0
	62	73	377.9	377.9	55.4	285.7	285.7	62.8
		87	388.6	388.6	53.9	293.2	293.2	61.7
		102	396.6	396.6	52.8	299.0	299.0	60.9
85	67	73	407.5	362.3	56.2	286.6	286.6	62.9
		87	426.8	370.0	54.8	294.2	294.2	61.8
		102	442.8	376.5	53.7	300.1	300.1	60.9
	72	73	489.7	316.0	58.4	331.0	260.1	64.1
		87	521.5	327.9	57.0	349.3	266.3	63.0
		102	547.9	337.9	55.7	365.1	271.7	62.2

Table PD-12. SCWF/SIWF 29 - Economizer Low Capacity - 11,600 cfm

Entering Air		Entering Water Temp						
EDB F	EWB F	Flow gpm	Total MBh	45 F			55 F	
				Sensible MBh	LWT F	Total MBh	Sensible MBh	LWT F
	62	73	200.6	193.8	50.5	133.0	133.0	58.6
		87	209.8	206.5	49.8	137.3	137.3	58.2
		102	217.4	209.6	49.3	140.7	140.7	57.8
75	67	73	251.7	164.8	51.9	145.8	126.7	59.0
		87	268.6	171.2	51.2	153.5	129.3	58.5
		102	282.3	176.4	50.5	160.5	131.8	58.1
	72	73	321.4	129.8	53.8	209.9	92.5	60.7
		87	343.5	137.7	52.9	223.9	97.0	60.1
		102	361.6	144.1	52.1	235.8	100.9	59.6
	62	73	229.7	229.7	51.3	166.2	166.2	59.6
		87	237.9	237.9	50.5	171.6	171.6	58.9
		102	244.1	244.1	49.8	175.9	175.9	58.4
80	67	73	254.7	215.0	52.0	166.6	159.4	59.6
		87	269.9	220.8	51.2	172.4	165.1	59.0
		102	282.5	225.6	50.5	177.4	170.0	58.5
	72	73	320.7	179.0	53.8	209.2	141.7	60.7
		87	342.8	186.8	52.9	223.2	146.2	60.1
		102	360.8	193.2	52.1	235.0	150.0	59.6
	62	73	262.7	262.7	52.2	199.5	199.5	60.5
		87	271.9	271.9	51.3	205.9	205.9	59.7
		102	279.0	279.0	50.5	211.0	211.0	59.1
85	67	73	269.4	261.6	52.4	199.9	199.9	60.5
		87	282.0	274.4	51.5	206.3	206.3	59.7
		102	292.4	278.4	50.7	211.5	211.5	59.1
	72	73	320.3	228.1	53.8	216.1	193.2	60.9
		87	342.1	235.8	52.9	227.6	196.9	60.2
		102	360.0	242.2	52.1	237.6	200.2	59.7



Performance Data

Water-Cooled 29 Ton

Table PD-13. SCWF/SIWF 29 Gross Cooling Capacity - 11,600 cfm, 87 gpm

Entering Air		Entering Water Temp								
		75 F			85 F			95 F		
EDB F	EWB F	Total MBh	Sensible MBh	LWT	Total MBh	Sensible MBh	LWT	Total MBh	Sensible MBh	LWT
75	62	335	266	84.2	323	259	94.1	309	254	104.0
	67	365	211	84.9	352	206	94.8	337	201	104.7
	72	397	157	85.6	383	152	95.5	366	146	105.4
80	62	336	315	84.2	325	309	94.1	311	301	104.0
	67	365	262	84.9	352	256	94.8	337	251	104.6
	72	396	208	85.6	381	202	95.5	366	196	105.4
85	62	347	347	84.4	337	337	94.4	325	325	104.3
	67	365	312	84.9	351	306	94.8	337	300	104.7
	72	396	258	85.6	381	253	95.5	366	246	105.3

Chart PD-33. SCWF/SIWF 29 Fan Performance for CV or with VFD

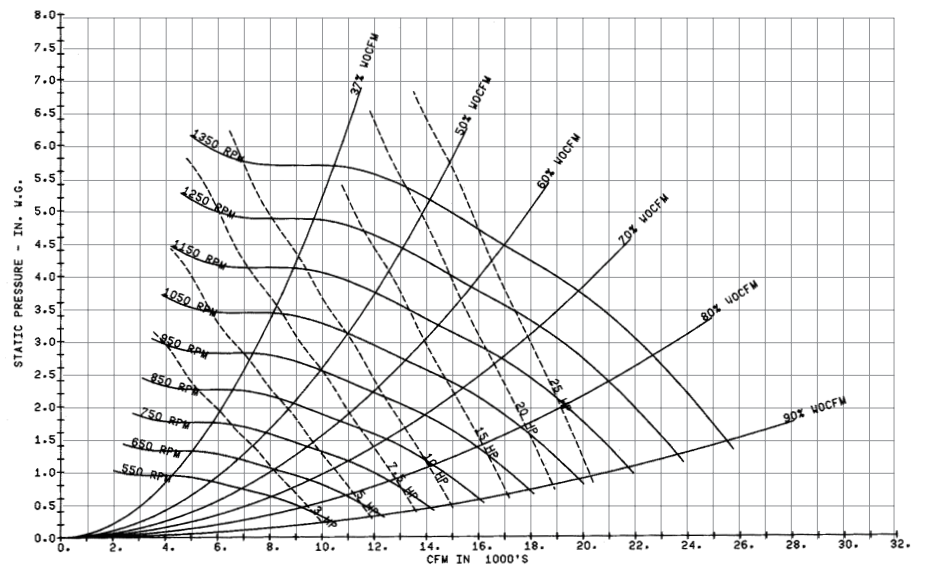
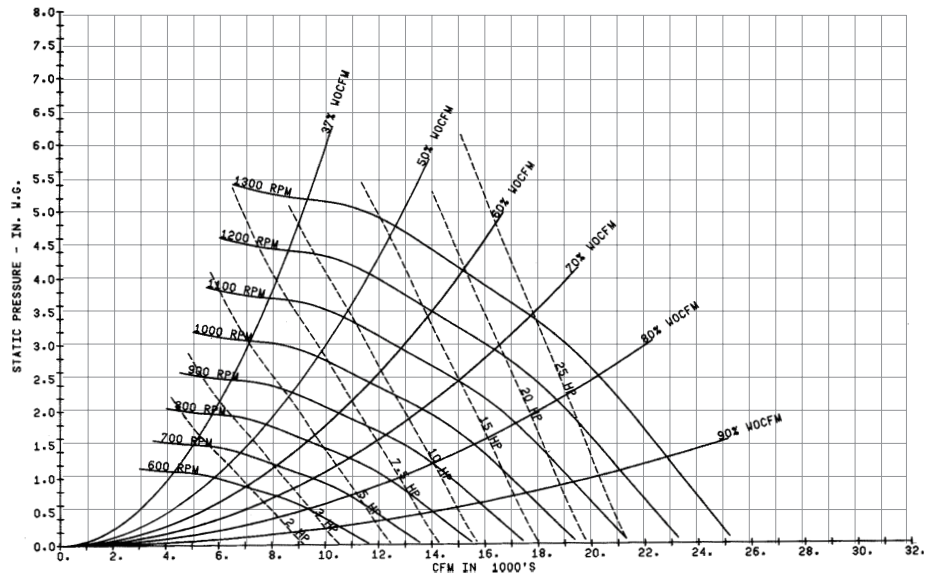

Chart PD-34. SCWF/SIWF 29 Fan Performance with Inlet Guide Vanes



Note:

1. Fan curves include refrigerant coil and internal cabinet static losses. To determine static pressure to be used with these curves, add filter, economizer, flexible horizontal discharge and heat pressure drops to external duct static pressure.



Performance Data

Water-Cooled 32 Ton

Table PD-14. SCWF/SIWF 32 - Economizer Full Capacity - 12,800 cfm

Entering Air		Entering Water Temp						
EDB F	EWB F	Flow gpm	45 F			55 F		
			Total MBh	Sensible MBh	LWT F	Total MBh	Sensible MBh	LWT F
	62	80	325.8	296.8	53.1	206.2	206.2	60.2
		96	340.9	303.2	52.1	212.0	212.0	59.4
		102	345.5	305.1	51.8	213.7	213.7	59.2
75	67	80	410.8	250.1	55.3	239.5	186.4	61.0
		96	438.2	260.9	54.1	252.7	191.1	60.3
		102	446.8	264.3	53.8	257.1	192.7	60.0
	72	80	524.5	207.6	58.1	341.3	144.0	63.5
		96	561.3	221.1	56.7	366.1	152.2	62.6
		102	572.8	225.3	56.2	374.0	154.9	62.3
	62	80	359.2	351.8	54.0	257.7	257.7	61.4
		96	371.0	363.6	52.7	264.8	264.8	60.5
		102	374.6	367.2	52.3	266.9	266.9	60.2
80	67	80	419.5	320.1	55.5	265.0	262.1	61.6
		96	443.6	329.6	54.2	275.3	265.8	60.7
		102	451.2	332.6	53.8	278.6	267.0	60.5
	72	80	523.3	274.5	58.1	342.0	211.3	63.6
		96	560.0	288.2	56.7	365.5	219.1	62.6
		102	571.4	292.5	56.2	373.1	221.7	62.3
	62	80	409.2	409.2	55.2	309.1	309.1	62.7
		96	420.9	420.9	53.8	317.6	317.6	61.6
		102	424.4	424.4	53.3	320.1	320.1	61.3
85	67	80	439.0	394.1	56.0	310.1	310.1	62.8
		96	459.6	402.3	54.6	318.6	318.6	61.6
		102	466.1	404.9	54.1	321.2	321.2	61.3
	72	80	526.4	342.5	58.2	355.4	282.6	63.9
		96	560.6	355.2	56.7	375.4	289.3	62.8
		102	571.4	359.3	56.2	381.8	291.5	62.5

Table PD-15. SCWF/SIWF 32 - Economizer Low Capacity - 12,800 cfm

Entering Air		Entering Water Temp						
EDB F	EWB F	Flow gpm	45 F			55 F		
			Total MBh	Sensible MBh	LWT F	Total MBh	Sensible MBh	LWT F
	62	80	214.8	207.4	50.4	142.6	142.6	58.6
		96	224.4	222.7	49.7	147.3	147.3	58.1
		102	227.4	223.9	49.5	148.7	148.7	57.9
75	67	80	268.8	177.2	51.7	155.5	136.5	58.9
		96	286.5	183.8	51.0	163.6	139.3	58.4
		102	292.0	185.9	50.7	166.4	140.3	58.3
	72	80	343.2	138.9	53.6	223.5	99.0	60.6
		96	366.3	147.1	52.6	238.5	103.8	60.0
		102	373.5	149.6	52.3	243.3	105.3	59.8
	62	80	246.7	246.7	51.2	178.3	178.3	59.5
		96	255.3	255.3	50.3	184.1	184.1	58.8
		102	257.8	257.8	50.1	185.9	185.9	58.6
80	67	80	272.1	231.7	51.8	178.6	178.6	59.5
		96	287.9	237.7	51.0	184.7	176.7	58.8
		102	292.9	239.6	50.7	186.7	178.6	58.7
	72	80	342.5	192.3	53.6	222.8	152.4	60.6
		96	365.5	200.4	52.6	237.7	157.2	60.0
		102	372.7	202.9	52.3	242.5	158.7	59.8
	62	80	282.0	282.0	52.0	214.0	214.0	60.3
		96	291.8	291.8	51.1	220.9	220.9	59.6
		102	294.7	294.7	50.8	223.0	223.0	59.4
85	67	80	288.3	279.8	52.2	214.4	214.4	60.4
		96	301.4	296.0	51.3	221.3	221.3	59.6
		102	305.5	297.6	51.0	223.5	223.5	59.4
	72	80	342.0	245.6	53.5	230.4	208.3	60.8
		96	364.8	253.6	52.6	242.5	212.2	60.1
		102	371.9	256.1	52.3	246.5	213.5	59.8

Performance Data

Water-Cooled 32 Ton

Table PD-16. SCWF/SIWF 32 Gross Cooling Capacity - 12,800 cfm, 96 gpm

Entering Air		Entering Water Temp								
		75 F			85 F			95 F		
EDB F	EWB F	Total MBh	Sensible MBh	LWT	Total MBh	Sensible MBh	LWT	Total MBh	Sensible MBh	LWT
75	62	367	317	83.9	352	310	93.8	337	303	103.7
	67	398	246	84.6	382	240	94.5	365	233	104.3
	72	432	175	85.3	415	169	95.2	397	163	105.0
80	62	374	372	84.1	361	360	94.0	348	348	103.9
	67	398	313	84.6	382	307	94.5	365	300	104.3
	72	431	241	85.3	415	236	95.2	397	229	105.0
85	62	393	393	84.5	380	380	94.4	367	367	104.3
	67	401	377	84.7	386	370	94.6	369	361	104.4
	72	431	308	85.3	414	302	95.2	395	296	105.0

Chart PD-35. SCWF/SIWF 32 Fan Performance for CV or with VFD

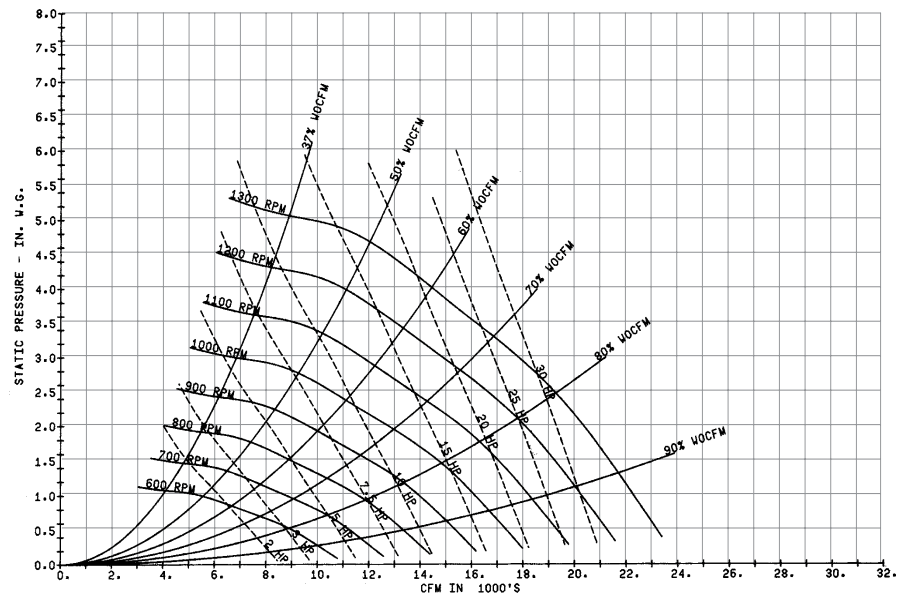
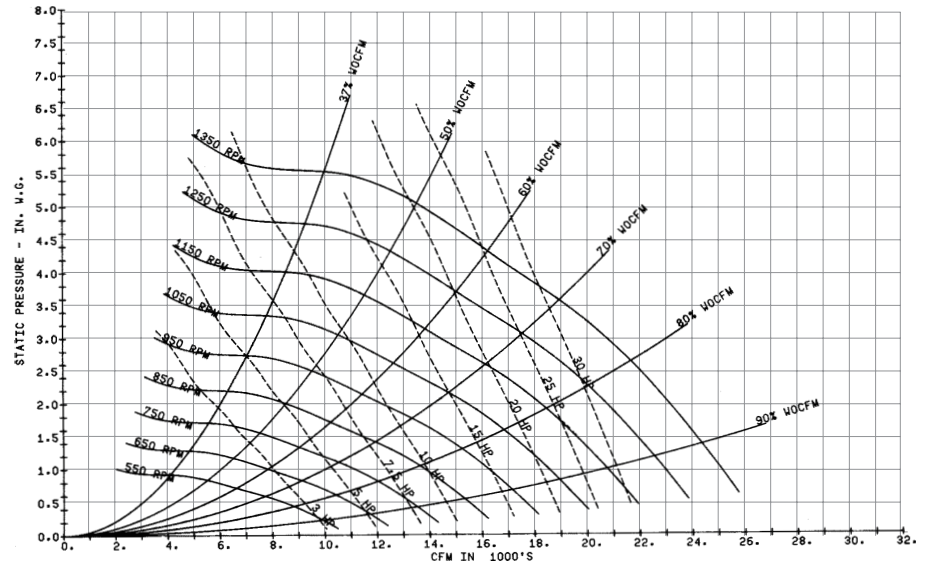

Chart PD-36. SCWF/SIWF 32 Fan Performance with Inlet Guide Vanes



Note:

1. Fan curves include refrigerant coil and internal cabinet static losses. To determine static pressure to be used with these curves, add filter, economizer, flexible horizontal discharge and heat pressure drops to external duct static pressure.



Performance Data

Water-Cooled 35 Ton

Table PD-17. SCWF/SIWF 35 - Economizer Full Capacity - 14,000 cfm

Entering Air			Entering Water Temp					
			45 F			55 F		
EDB	EWB	Flow	Total	Sensible	LWT	Total	Sensible	LWT
F	F	gpm	MBh	MBh	F	MBh	MBh	F
	62	88	335.2	309.5	52.6	212.8	212.8	59.8
		105	349.5	315.4	51.7	218.4	218.4	59.2
		119	358.9	319.4	51.0	221.9	221.9	58.7
75	67	88	425.7	260.8	54.7	246.3	194.3	60.6
		105	451.9	271.0	53.6	259.2	198.8	59.9
		119	469.1	277.9	52.9	268.1	202.0	59.5
	72	88	544.6	216.1	57.4	354.1	149.9	63.0
		105	579.2	228.9	56.0	377.7	157.7	62.2
		119	602.1	237.4	55.1	393.3	162.9	61.6
80	62	88	370.3	362.2	53.4	265.9	265.9	61.0
		105	381.4	373.3	52.3	272.9	272.9	60.2
		119	388.6	380.5	51.5	277.3	277.3	59.7
	67	88	432.4	333.5	54.8	272.4	263.1	61.2
		105	455.5	342.6	53.7	282.1	277.2	60.4
		119	470.9	348.7	52.9	288.7	279.6	59.9
	72	88	543.4	286.3	57.3	353.7	220.4	63.0
		105	577.9	299.0	56.0	376.4	228.0	62.2
		119	600.6	307.6	55.1	391.9	233.1	61.6
85	62	88	422.4	422.4	54.6	319.0	319.0	62.2
		105	433.8	433.8	53.3	327.3	327.3	61.2
		119	440.9	440.9	52.4	332.5	332.5	60.6
	67	88	451.5	410.9	55.3	319.9	319.9	62.3
		105	471.1	418.7	54.0	328.3	328.3	61.3
		119	484.1	423.9	53.1	333.5	333.5	60.6
	72	88	544.2	357.0	57.4	365.6	294.8	63.3
		105	577.1	369.2	56.0	384.6	301.2	62.3
		119	599.3	377.5	55.1	397.7	305.6	61.7

Table PD-18. SCWF/SIWF 35 - Economizer Low Capacity - 14,000 cfm

Entering Air			Entering Water Temp					
			45 F			55 F		
EDB	EWB	Flow	Total	Sensible	LWT	Total	Sensible	LWT
F	F	gpm	MBh	MBh	F	MBh	MBh	F
	62	88	216.3	208.3	49.9	143.3	143.3	58.3
		105	224.9	223.6	49.3	147.5	147.5	57.8
		119	230.7	225.9	48.9	150.3	150.3	57.5
75	67	88	274.3	179.6	51.2	157.0	137.4	58.6
		105	290.2	185.6	50.5	164.7	140.1	58.1
		119	300.7	189.6	50.1	170.1	142.0	57.9
	72	88	350.3	141.5	53.0	228.0	100.5	60.2
		105	371.3	148.9	52.1	241.7	105.0	59.6
		119	385.1	153.9	51.5	250.9	107.9	59.2
80	62	88	248.2	248.2	50.6	179.2	179.2	59.1
		105	255.9	255.9	49.9	184.4	184.4	58.5
		119	260.8	260.8	49.4	187.8	187.8	58.2
	67	88	275.7	233.7	51.3	179.5	179.5	59.1
		105	290.3	239.2	50.5	184.9	176.3	58.5
		119	300.2	243.0	50.0	188.6	179.9	58.2
	72	88	349.6	195.1	52.9	227.3	154.2	60.2
		105	370.5	202.4	52.1	241.0	158.6	59.6
		119	384.3	207.4	51.5	250.1	161.5	59.2
85	62	88	283.7	283.7	51.4	215.0	215.0	59.9
		105	292.5	292.5	50.6	221.3	221.3	59.2
		119	298.0	298.0	50.0	225.3	225.3	58.8
	67	88	290.3	281.2	51.6	215.4	215.4	59.9
		105	302.1	297.2	50.8	221.7	221.7	59.2
		119	310.0	300.2	50.2	225.7	225.7	58.8
	72	88	348.9	248.6	52.9	232.4	209.6	60.3
		105	369.7	255.9	52.0	243.8	213.2	59.6



Performance Data

Water-Cooled 35 Ton

Table PD-19. SCWF/SIWF 35 Gross Cooling Capacity - 14,000 cfm, 105 gpm

Entering Air		Entering Water Temp								
		75 F			85 F			95 F		
EDB F	EWB F	Total MBh	Sensible MBh	LWT	Total MBh	Sensible MBh	LWT	Total MBh	Sensible MBh	LWT
75	62	401	320	84.1	386	313	94.0	369	306	103.9
	67	436	254	84.8	420	247	94.7	402	240	104.6
	72	474	188	85.5	456	182	95.4	437	175	105.3
80	62	402	381	84.1	388	373	94.0	373	365	104.0
	67	436	316	84.8	419	309	94.7	402	302	104.6
	72	473	250	85.5	455	243	95.4	436	236	105.3
85	62	419	419	84.4	406	406	94.4	392	392	104.4
	67	435	377	84.8	419	370	94.7	402	363	104.6
	72	473	311	85.5	455	304	95.4	436	297	105.2

Chart PD-37. SCWF/SIWF 35 Fan Performance for CV or with VFD

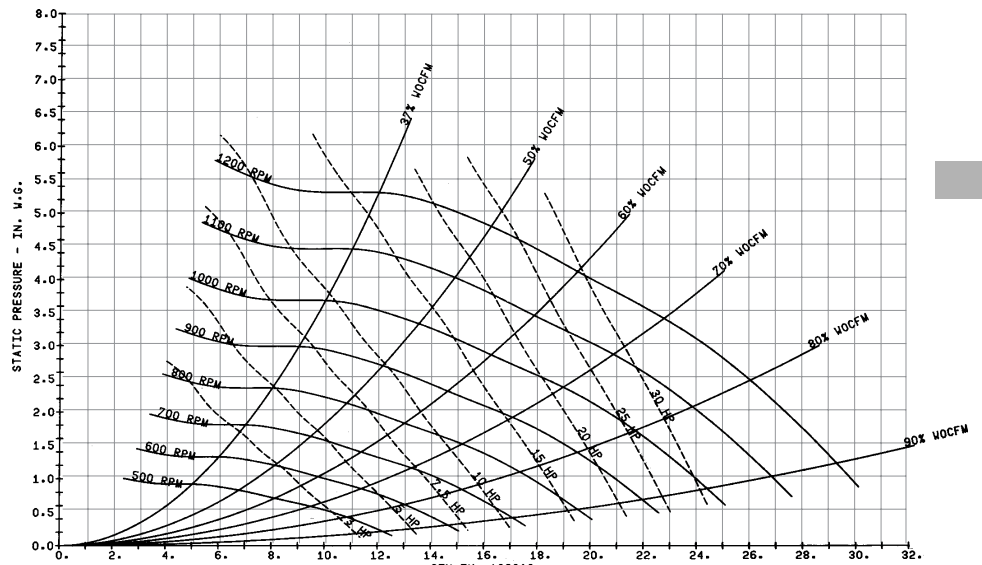
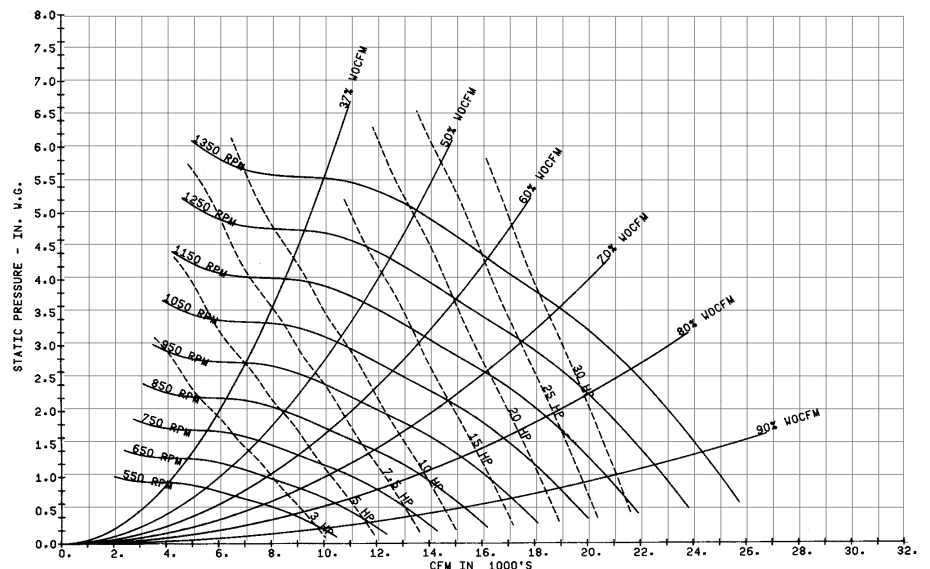

Chart PD-38. SCWF/SIWF 35 Fan Performance with Inlet Guide Vanes



Note:

1. Fan curves include refrigerant coil and internal cabinet static losses. To determine static pressure to be used with these curves, add filter, economizer, flexible horizontal discharge and heat pressure drops to external duct static pressure.



Performance Data

Water-Cooled 38 Ton

Table PD-20. SCWF/SIWF 38 - Economizer Full Capacity - 15,200 cfm

Entering Air			45 F			55 F		
EDB	EWB	Flow	Total	Sensible	LWT	Total	Sensible	LWT
F	F	gpm	MBh	MBh	F	MBh	MBh	F
	62	95	355.5	330.9	52.5	226.5	226.5	59.8
		114	370.6	337.2	51.5	232.7	232.7	59.1
		119	374.1	338.7	51.3	234.0	234.0	58.9
75	67	95	450.7	277.7	54.5	260.8	207.6	60.5
		114	478.7	288.7	53.4	274.4	212.4	59.8
		119	485.0	291.2	53.2	277.6	213.5	59.7
	72	95	576.2	229.0	57.1	374.4	159.1	62.9
		114	613.4	242.7	55.8	399.7	167.5	62.0
		119	621.8	245.8	55.4	405.4	169.4	61.8
80	62	95	394.0	385.2	53.3	283.0	283.0	61.0
		114	405.8	397.1	52.1	290.7	290.7	60.1
		119	408.5	399.7	51.9	292.4	292.4	59.9
	67	95	457.8	356.0	54.6	289.1	279.0	61.1
		114	482.4	365.7	53.5	299.5	296.9	60.3
		119	488.0	367.9	53.2	301.8	297.8	60.1
	72	95	574.9	304.5	57.1	374.0	235.0	62.9
		114	612.0	318.2	55.7	398.4	243.1	62.0
		119	620.3	321.3	55.4	404.0	245.0	61.8
85	62	95	449.7	449.7	54.5	339.5	339.5	62.1
		114	462.2	462.2	53.1	348.7	348.7	61.1
		119	464.8	464.8	52.8	350.7	350.7	60.9
	67	95	478.6	439.4	55.1	340.5	340.5	62.2
		114	499.4	447.7	53.8	349.7	349.7	61.1
		119	504.2	449.6	53.5	351.7	351.7	60.9
	72	95	575.8	380.7	57.1	386.7	315.1	63.1
		114	611.1	393.6	55.7	407.1	321.9	62.1
		119	619.2	396.6	55.4	411.8	323.5	61.9

Table PD-21. SCWF/SIWF 38 - Economizer Low Capacity - 15,200 cfm

Entering Air			Entering Water Temp					
			45 F			55 F		
EDB	EWB	Flow	Total	Sensible	LWT	Total	Sensible	LWT
F	F	gpm	MBh	MBh	F	MBh	MBh	F
	62	95	228.0	219.3	49.8	151.4	151.4	58.2
		114	237.0	228.2	49.2	155.9	155.9	57.7
		119	239.0	238.1	49.0	156.9	156.9	57.6
75	67	95	288.5	190.0	51.1	165.1	145.8	58.5
		114	305.2	196.3	50.4	173.1	148.5	58.0
		119	308.9	197.7	50.2	175.0	149.2	57.9
	72	95	368.4	149.1	52.8	239.5	106.0	60.0
		114	390.3	156.8	51.8	254.0	110.7	59.5
		119	395.3	158.6	51.6	257.3	111.8	59.3
80	62	95	262.3	262.3	50.5	189.2	189.2	59.0
		114	270.4	270.4	49.7	194.9	194.9	58.4
		119	272.2	272.2	49.6	196.1	196.1	58.3
	67	95	290.0	247.8	51.1	189.5	189.5	59.0
		114	305.3	253.5	50.4	195.2	185.9	58.4
		119	308.8	254.8	50.2	196.5	187.2	58.3
	72	95	367.6	206.3	52.7	238.7	163.2	60.0
		114	389.5	213.9	51.8	253.2	167.9	59.4
		119	394.5	215.7	51.6	256.4	168.9	59.3
85	62	95	299.8	299.8	51.3	227.1	227.1	59.8
		114	309.1	309.1	50.4	233.8	233.8	59.1
		119	311.1	311.1	50.2	235.3	235.3	59.0
	67	95	305.9	296.1	51.4	227.5	227.5	59.8
		114	318.2	315.4	50.6	234.2	234.2	59.1
		119	321.0	316.5	50.4	235.7	235.7	59.0
	72	95	366.9	263.3	52.7	244.3	222.3	60.1
		114	388.7	270.9	51.8	256.2	226.2	59.5
		119	393.6	272.7	51.6	259.0	227.1	59.4



Performance Data

Water-Cooled 38 Ton

Table PD-22. SCWF/SIWF 38 Gross Cooling Capacity - 15,200 cfm, 114 gpm

Entering Air		Entering Water Temp								
		75 F			85 F			95 F		
EDB F	EWB F	Total MBh	Sensible MBh	LWT	Total MBh	Sensible MBh	LWT	Total MBh	Sensible MBh	LWT
75	62	434	373	83.9	416	365	93.8	398	357	103.7
	67	471	290	84.6	452	283	94.5	432	275	104.3
	72	511	206	85.3	490	199	95.2	469	192	105.0
80	62	441	441	84.1	426	426	94.0	410	410	103.9
	67	470	369	84.6	452	361	94.5	432	353	104.3
	72	510	285	85.3	490	277	95.2	468	270	105.0
85	62	465	465	84.5	450	450	94.4	433	433	104.4
	67	473	444	84.7	455	435	94.5	436	425	104.4
	72	510	363	85.3	489	355	95.2	468	348	105.0

Chart PD-39. SCWF/SIWF 38 Fan Performance for CV or with VFD

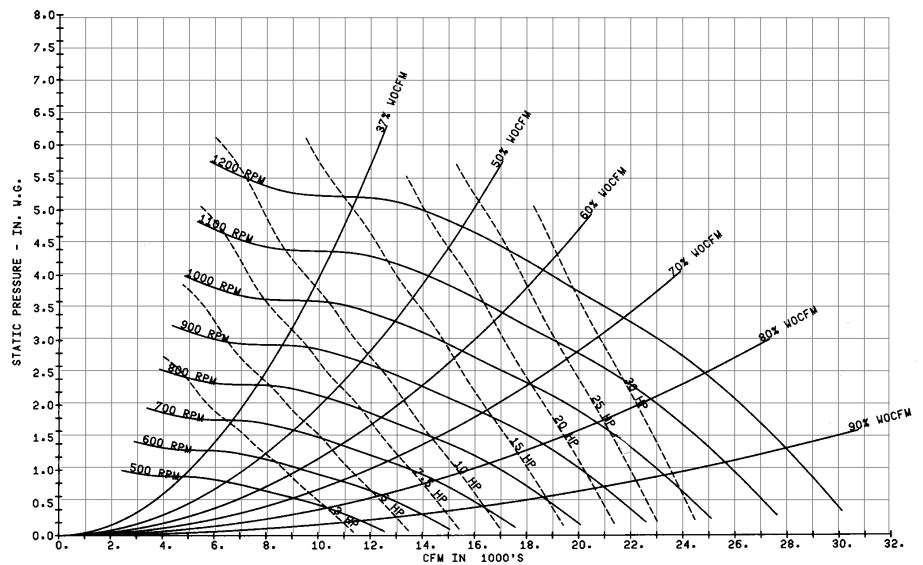
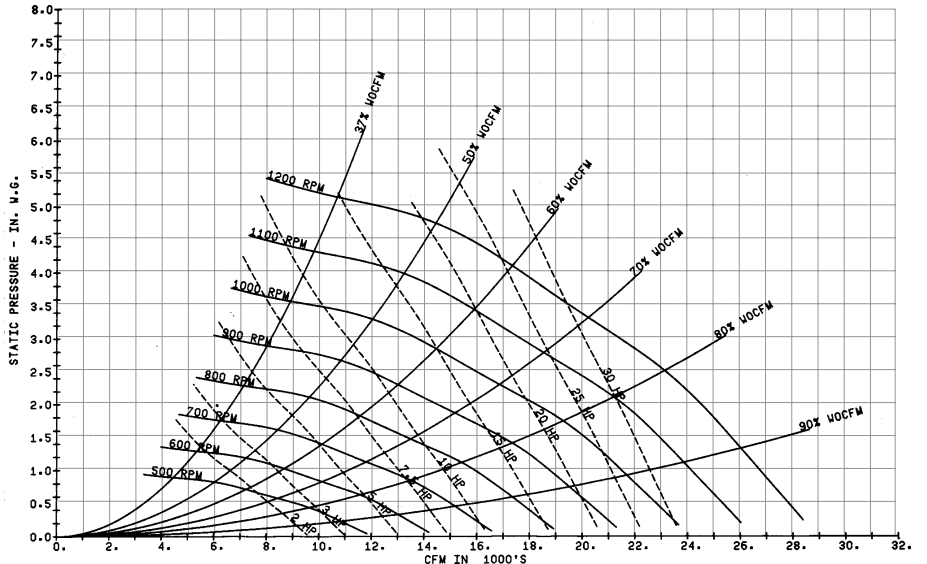

Chart PD-40. SCWF/SIWF 38 Fan Performance with Inlet Guide Vanes



Note:

1. Fan curves include refrigerant coil and internal cabinet static losses. To determine static pressure to be used with these curves, add filter, economizer, flexible horizontal discharge and heat pressure drops to external duct static pressure.



Performance Data

Water-Cooled 42 Ton

Table PD-23. SCWF/SIWF 42 - Economizer Full Capacity - 16,800 cfm

Entering Air		Entering Water Temp						
EDB F	EWB F	Flow gpm	Total MBh	45 F			55 F	
				Sensible MBh	LWT F	Total MBh	Sensible MBh	LWT F
	62	105	438.5	393.8	53.4	274.5	274.5	60.2
		126	457.1	401.7	52.3	281.4	281.4	59.5
		142	468.6	406.6	51.6	285.4	285.4	59.0
75	67	105	556.7	335.0	55.6	322.8	247.5	61.1
		126	591.2	348.7	54.4	339.9	253.6	60.4
		142	612.2	357.2	53.6	350.8	257.5	59.9
	72	105	711.9	281.0	58.6	462.2	193.6	63.8
		126	757.8	297.9	57.0	494.2	204.4	62.8
		142	786.0	308.5	56.1	513.6	211.0	62.2
	62	105	480.2	470.5	54.1	343.0	343.0	61.5
		126	494.6	484.9	52.9	351.6	351.6	60.6
		142	503.3	493.6	52.1	356.5	356.5	60.0
80	67	105	566.9	426.2	55.8	354.9	346.2	61.8
		126	597.1	438.3	54.5	367.9	350.9	60.8
		142	615.8	445.8	53.7	375.9	353.8	60.3
	72	105	710.3	368.9	58.5	462.7	281.8	63.8
		126	756.0	386.0	57.0	493.0	291.9	62.8
		142	784.0	396.7	56.0	511.9	298.3	62.2
	62	105	545.5	545.5	55.4	411.4	411.4	62.8
		126	559.4	559.4	53.9	421.6	421.6	61.7
		142	567.3	567.3	53.0	427.4	427.4	61.0
85	67	105	590.8	522.7	56.3	412.7	412.7	62.9
		126	616.6	533.0	54.8	423.0	423.0	61.7
		142	632.5	539.5	53.9	428.9	428.9	61.0
	72	105	712.7	457.3	58.6	479.1	374.9	64.1
		126	756.0	473.6	57.0	504.7	383.5	63.0
		142	782.8	483.8	56.0	520.7	388.9	62.3

Table PD-24. SCWF/SIWF 42 - Economizer Low Capacity - 16,800 cfm

Entering Air		Entering Water Temp						
EDB F	EWB F	Flow gpm	Total MBh	45 F			55 F	
				Sensible MBh	LWT F	Total MBh	Sensible MBh	LWT F
	62	105	291.1	290.3	50.5	191.1	191.1	58.6
		126	302.7	295.0	49.8	196.7	196.7	58.1
		142	310.0	298.0	49.4	200.0	200.0	57.8
75	67	105	368.9	238.2	52.0	211.6	181.4	59.0
		126	390.4	246.4	51.2	221.9	184.9	58.5
		142	403.6	251.5	50.7	228.7	187.3	58.2
	72	105	471.3	189.6	54.0	306.1	133.9	60.8
		126	499.6	199.7	52.9	325.0	140.0	60.2
		142	517.1	206.0	52.3	336.6	143.8	59.7
	62	105	331.6	331.6	51.3	238.9	238.9	59.6
		126	341.5	341.5	50.4	245.9	245.9	58.9
		142	347.4	347.4	49.9	250.0	250.0	58.5
80	67	105	566.9	426.2	55.8	354.9	346.2	61.8
		126	391.2	316.4	51.2	247.4	236.8	58.9
		142	403.5	321.1	50.7	252.1	241.5	58.6
	72	105	470.3	259.3	54.0	305.1	203.7	60.8
		126	498.5	269.3	52.9	323.9	209.7	60.1
		142	515.9	275.6	52.3	335.5	213.5	59.7
	62	105	379.0	379.0	52.2	286.7	286.7	60.5
		126	390.3	390.3	51.2	295.0	295.0	59.7
		142	397.0	397.0	50.6	299.9	299.9	59.2
85	67	105	390.9	385.8	52.4	287.3	287.3	60.5
		126	406.8	392.0	51.5	295.6	295.6	59.7
		142	416.8	395.8	50.9	300.5	300.5	59.2
	72	105	469.3	328.9	53.9	313.2	276.2	61.0
		126	497.4	338.8	52.9	328.7	281.3	60.2
		142	514.8	345.1	52.3	338.5	284.5	59.8

Performance Data

Water-Cooled 42 Ton

Table PD-25. SCWF/SIWF 42 Gross Cooling Capacity - 16,800 cfm, 126 gpm

Entering Air		Entering Water Temp								
		75 F			85 F			95 F		
EDB F	EWB F	Total MBh	Sensible MBh	LWT	Total MBh	Sensible MBh	LWT	Total MBh	Sensible MBh	LWT
75	62	488	403	84.1	469	394	94.1	449	385	104.0
	67	530	317	84.9	510	309	94.7	488	300	104.6
	72	576	231	85.6	554	223	95.5	531	215	105.3
80	62	493	473	84.3	476	460	94.2	458	445	104.1
	67	530	397	84.9	510	389	94.7	488	380	104.6
	72	576	311	85.6	554	303	95.5	530	295	105.3
85	62	513	512	84.6	496	496	94.5	479	479	104.5
	67	532	476	84.9	512	467	94.8	491	456	104.6
	72	575	391	85.6	553	383	95.5	530	375	105.3

Chart PD-41. SCWF/SIWF 42 Fan Performance for CV or with VFD

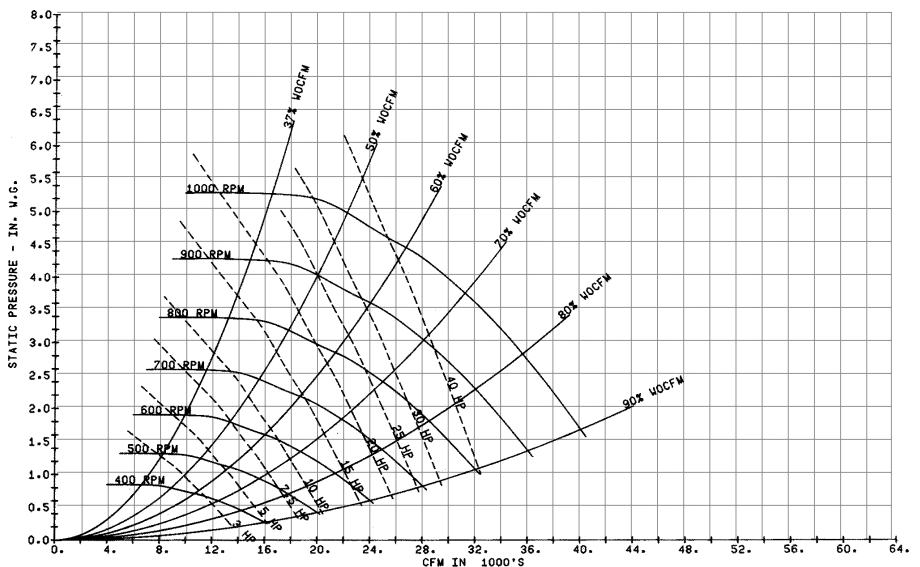
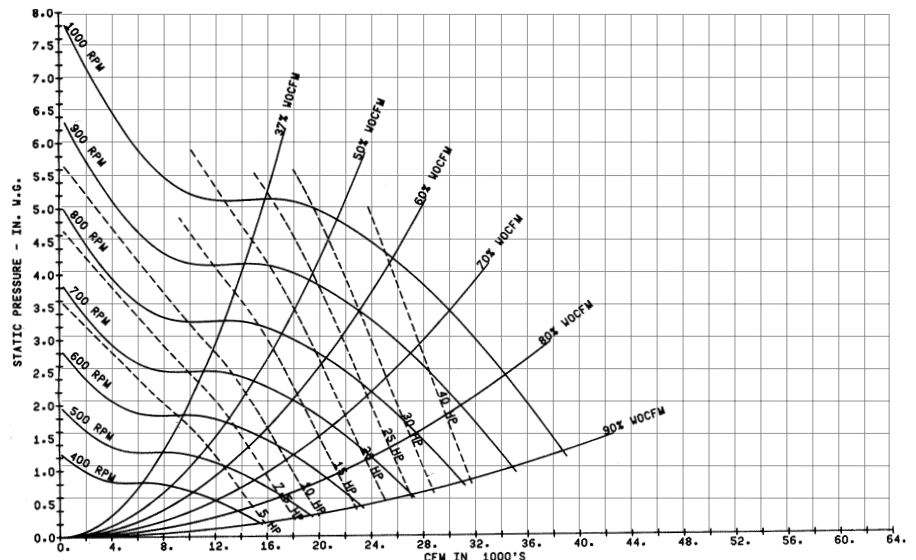

Chart PD-42. SCWF/SIWF 42 Fan Performance with Inlet Guide Vanes



Note:

1. Fan curves include refrigerant coil and internal cabinet static losses. To determine static pressure to be used with these curves, add filter, economizer, flexible horizontal discharge and heat pressure drops to external duct static pressure.



Performance Data

Water-Cooled 46 Ton

Table PD-26. SCWF/SIWF 46 - Economizer Full Capacity - 18,400 cfm

Entering Air		Entering Water Temp						
		45 F					55 F	
EDB F	EWB F	Flow gpm	Total MBh	Sensible MBh	LWT F	Total MBh	Sensible MBh	LWT F
	62	115	469.0	425.0	53.2	295.0	295.0	60.1
		138	488.5	433.3	52.1	302.5	302.5	59.4
		142	491.5	434.5	51.9	303.5	303.5	59.3
75	67	115	594.6	360.1	55.3	344.7	266.9	61.0
		138	630.9	374.4	54.1	362.5	273.2	60.3
		142	636.3	376.6	54.0	365.3	274.2	60.1
	72	115	760.7	300.9	58.2	493.5	207.5	63.6
		138	808.6	318.4	56.7	526.8	218.7	62.6
		142	815.8	321.1	56.5	531.8	220.3	62.5
62		115	515.3	504.7	54.0	368.6	368.6	61.4
		138	530.5	519.8	52.7	377.9	377.9	60.5
		142	532.7	522.0	52.5	379.2	379.2	60.3
80	67	115	605.5	459.2	55.5	380.0	374.4	61.6
		138	637.2	471.8	54.2	393.5	379.2	60.7
		142	642.0	473.7	54.0	395.6	380.0	60.6
	72	115	759.0	396.1	58.2	493.9	303.3	63.6
		138	806.6	413.9	56.7	525.5	313.9	62.6
		142	813.8	416.6	56.5	530.3	315.5	62.5
62		115	586.3	586.3	55.2	442.1	442.1	62.7
		138	601.2	601.2	53.7	453.1	453.1	61.6
		142	603.4	603.4	53.5	454.7	454.7	61.4
85	67	115	631.8	564.1	56.0	443.5	443.5	62.7
		138	658.8	574.9	54.5	454.6	454.6	61.6
		142	662.8	576.6	54.3	456.2	456.2	61.4
	72	115	761.0	492.1	58.2	511.5	404.5	63.9
		138	806.5	509.1	56.7	538.2	413.4	62.8
		142	813.3	511.6	56.5	542.2	414.8	62.6

Table PD-27. SCWF/SIWF 46 - Economizer Low Capacity - 18,400 cfm

Entering Air		Entering Water Temp						
		45 F					55 F	
EDB F	EWB F	Water Flow gpm	Total MBh	Sensible MBh	LWT F	Total MBh	Sensible MBh	LWT F
	62	115	309.1	298.4	50.4	203.6	203.6	58.5
		138	321.0	315.6	49.7	209.4	209.4	58.0
		142	322.8	316.3	49.5	210.3	210.3	58.0
75	67	115	390.9	254.1	51.8	224.1	194.0	58.9
		138	413.0	262.5	51.0	234.6	197.6	58.4
		142	416.4	263.8	50.9	236.3	198.2	58.3
	72	115	499.2	201.2	53.7	324.1	142.3	60.6
		138	528.4	211.6	52.7	343.5	148.6	60.0
		142	532.8	213.1	52.5	346.4	149.6	59.9
62		115	353.2	353.2	51.1	254.4	254.4	59.4
		138	363.6	363.6	50.3	261.7	261.7	58.8
		142	365.1	365.1	50.1	262.8	262.8	58.7
80	67	115	394.0	330.3	51.9	255.0	243.6	59.4
		138	413.9	337.9	51.0	262.9	251.4	58.8
		142	417.0	339.1	50.9	264.1	252.5	58.7
	72	115	498.1	276.3	53.7	323.0	217.5	60.6
		138	527.3	286.6	52.6	342.3	223.7	60.0
		142	531.6	288.1	52.5	345.2	224.7	59.9
62		115	403.6	403.6	52.0	305.3	305.3	60.3
		138	415.5	415.5	51.0	314.0	314.0	59.6
		142	417.2	417.2	50.9	315.3	315.3	59.4
85	67	115	414.9	413.1	52.2	305.9	305.9	60.3
		138	431.2	419.4	51.2	314.6	314.6	59.6
		142	433.7	420.3	51.1	315.9	315.9	59.4
	72	115	497.1	351.2	53.6	331.7	295.6	60.8
		138	526.1	361.4	52.6	347.6	300.7	60.0
		142	530.5	363.0	52.5	350.0	301.5	59.9

Performance Data

Water-Cooled 46 Ton

Table PD-28. SCWF/SIWF 46 Gross Cooling Capacity - 18,400 cfm, 138 gpm

Entering Air		Entering Water Temp								
		75 F			85 F			95 F		
EDB F	EWB F	Total MBh	Sensible MBh	LWT	Total MBh	Sensible MBh	LWT	Total MBh	Sensible MBh	LWT
75	62	517	449	83.8	498	439	93.6	476	429	103.5
	67	561	348	84.4	540	340	94.3	516	331	104.1
	72	609	248	85.1	586	239	95.0	561	231	104.8
80	62	530	520	84.0	511	505	93.9	491	488	103.8
	67	562	444	84.4	539	435	94.3	516	425	104.1
	72	609	343	85.1	586	334	95.0	560	325	104.8
85	62	556	556	84.4	538	538	94.3	518	518	104.2
	67	567	533	84.5	546	521	94.4	524	505	104.3
	72	609	437	85.1	585	428	95.0	559	420	104.5

Chart PD-43. SCWF/SIWF 46 Fan Performance for CV or with VFD

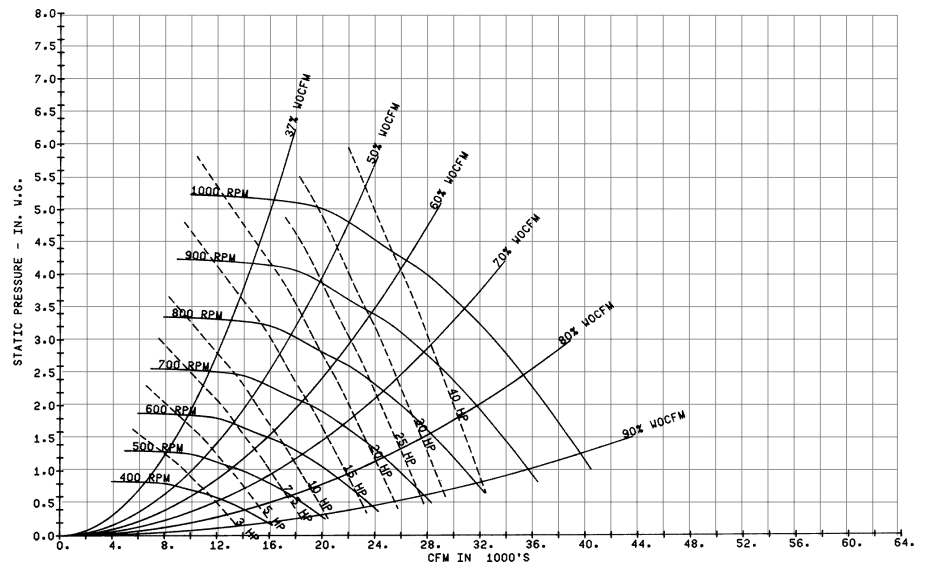
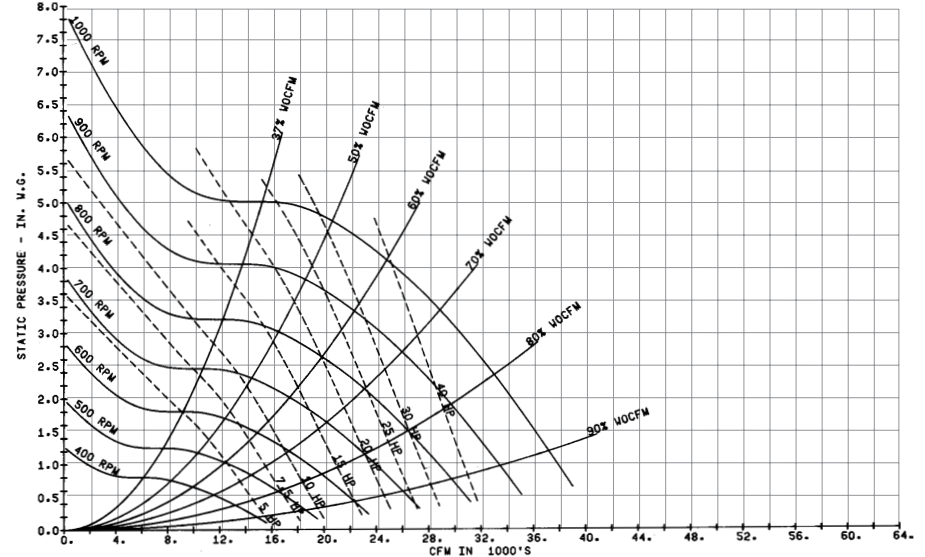

Chart PD-44. SCWF/SIWF 46 Fan Performance with Inlet Guide Vanes



Note:

1. Fan curves include refrigerant coil and internal cabinet static losses. To determine static pressure to be used with these curves, add filter, economizer, flexible horizontal discharge and heat pressure drops to external duct static pressure.



Performance Data

Water-Cooled 52 Ton

Table PD-29. SCWF/SIWF 52 - Economizer Full Capacity - 20,800 cfm

Entering Air		Entering Water Temp								
		45 F			55 F					
EDB F	EWB F	Flow gpm	Total MBh	Sensible MBh	LWT F	Total MBh	Sensible MBh	LWT F		
75	62	130	546.6	489.7	53.4	341.8	341.8	60.3		
		156	570.0	499.6	52.3	350.4	350.4	59.5		
		182	588.4	507.5	51.5	356.6	356.6	58.9		
	67	75	130	694.3	417.0	55.7	402.7	307.8	61.2	
			156	737.5	434.2	54.5	424.2	315.4	60.4	
			182	771.2	447.8	53.5	441.7	321.7	59.9	
		72	75	130	887.8	350.3	58.7	576.6	241.3	63.9
				156	945.5	371.6	57.1	616.7	254.8	62.9
				182	990.6	388.5	55.9	647.8	265.4	62.1
80	62	130	598.2	586.1	54.2	427.0	427.0	61.6		
		156	616.2	604.1	52.9	437.6	437.6	60.6		
		182	630.1	618.1	51.9	445.4	445.4	59.9		
	67	80	130	707.0	530.2	55.9	442.3	430.2	61.8	
			156	744.9	545.4	54.5	458.6	436.1	60.9	
			182	774.8	557.5	53.5	471.5	440.8	60.2	
		72	80	130	885.8	459.3	58.6	577.3	350.6	63.9
				156	943.2	480.9	57.1	615.2	363.4	62.9
				182	988.1	498.1	55.9	645.6	373.7	62.1
85	62	130	679.1	679.1	55.4	512.1	512.1	62.9		
		156	696.3	696.3	53.9	524.8	524.8	61.7		
		182	708.9	708.9	52.8	534.0	534.0	60.9		
	67	85	130	736.6	649.9	56.3	513.8	513.8	62.9	
			156	769.0	662.9	54.9	526.6	526.6	61.8	
			182	794.5	673.3	53.7	535.8	535.8	60.9	
		72	85	130	888.9	569.1	58.7	597.7	466.2	64.2
				156	943.3	589.5	57.1	629.7	477.0	63.1
				182	986.2	606.0	55.8	655.5	485.8	62.2

Table PD-30. SCWF/SIWF 52 - Economizer Low Capacity - 20,800 cfm

Entering Air		Entering Water Temp								
		45 F			55 F					
EDB F	EWB F	Flow gpm	Total MBh	Sensible MBh	LWT F	Total MBh	Sensible MBh	LWT F		
75	62	130	363.7	361.8	50.6	238.6	238.6	58.7		
		156	378.3	367.7	49.9	245.6	245.6	58.1		
		182	390.1	372.6	49.3	250.9	250.9	57.8		
	67	75	130	461.2	297.3	52.1	264.6	226.1	59.1	
			156	488.3	307.6	51.3	277.6	230.6	58.6	
			182	509.6	315.8	50.6	288.6	234.5	58.2	
		72	75	130	589.2	236.9	54.1	382.8	167.2	60.9
				156	625.0	249.6	53.0	406.6	174.9	60.2
				182	653.2	259.8	52.2	425.4	181.1	59.7
80	62	130	413.9	413.9	51.4	298.2	298.2	59.6		
		156	426.4	426.4	50.5	306.9	306.9	58.9		
		182	435.8	435.8	49.8	313.5	313.5	58.4		
	67	80	130	464.9	385.4	52.2	299.4	286.4	59.6	
			156	489.3	394.7	51.3	309.0	295.9	59.0	
			182	509.2	402.3	50.6	316.7	303.6	58.5	
		72	80	130	588.0	323.6	54.0	381.6	254.0	60.9
				156	623.6	336.3	53.0	405.2	261.7	60.2
				182	651.7	346.4	52.2	423.9	267.8	59.7
85	62	130	473.1	473.1	52.3	357.9	357.9	60.5		
		156	487.2	487.2	51.2	368.3	368.3	59.7		
		182	497.9	497.9	50.5	376.1	376.1	59.1		
	67	85	130	488.4	480.9	52.5	358.6	358.6	60.5	
			156	508.5	488.6	51.5	369.0	369.0	59.7	
			182	524.8	494.9	50.8	376.9	376.9	59.1	
		72	85	130	586.7	410.2	54.0	391.6	344.3	61.0
				156	622.2	422.8	53.0	411.1	350.7	60.3
				182	650.2	432.9	52.1	427.1	355.9	59.7



Performance Data

Water-Cooled 52 Ton

Table PD-31. SCWF/SIWF 52 Gross Cooling Capacity - 20,800 cfm, 156 gpm

Entering Air		Entering Water Temp								
		75 F			85 F			95 F		
EDB F	EWB F	Total MBh	Sensible MBh	LWT	Total MBh	Sensible MBh	LWT	Total MBh	Sensible MBh	LWT
75	62	596	471	84.1	575	461	94.0	551	450	103.9
	67	650	376	84.8	626	366	94.7	601	356	104.6
	72	707	280	85.5	681	271	95.4	654	261	105.3
80	62	598	559	84.1	577	548	94.0	555	535	104.0
	67	649	465	84.8	626	455	94.7	600	445	104.6
	72	706	369	85.5	680	360	95.4	653	350	105.3
85	62	616	616	84.3	598	598	94.3	579	579	104.3
	67	649	554	84.8	625	544	94.7	601	533	104.6
	72	705	458	85.5	680	448	95.4	653	438	105.3

Chart PD-45. SCWF/SIWF 52 Fan Performance for CV or with VFD

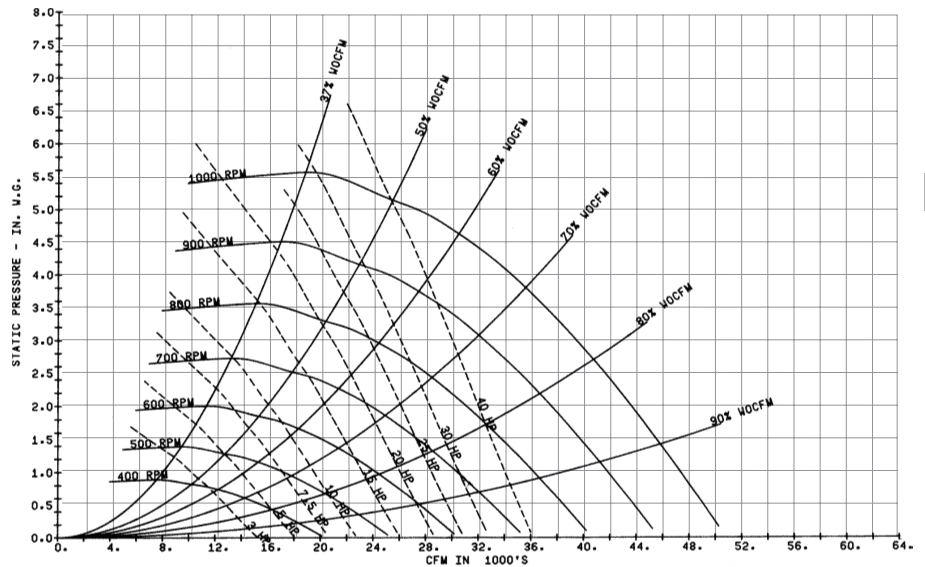
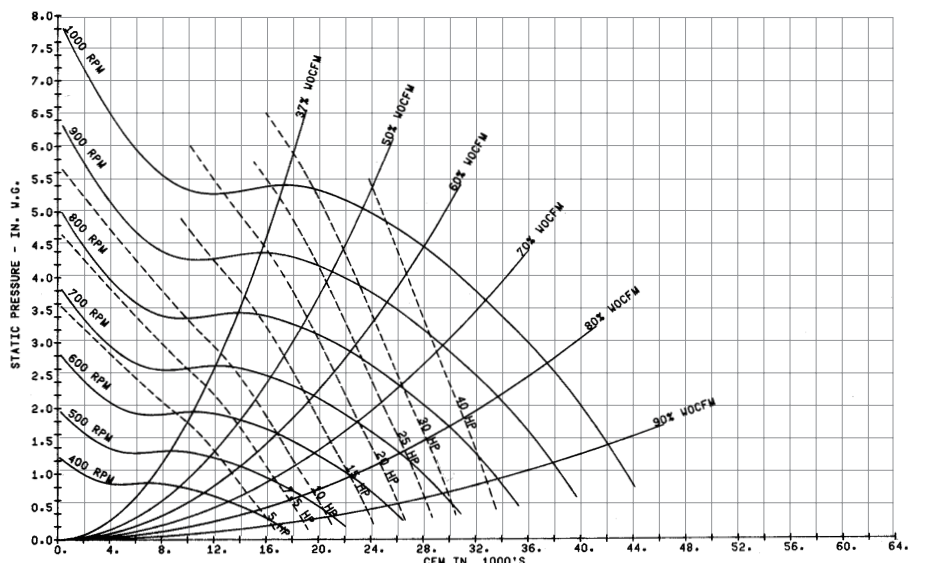

Chart PD-46. SCWF/SIWF 52 Fan Performance with Inlet Guide Vanes



Note:

1. Fan curves include refrigerant coil and internal cabinet static losses. To determine static pressure to be used with these curves, add filter, economizer, flexible horizontal discharge and heat pressure drops to external duct static pressure.



Performance Data

Water-Cooled 58 Ton

Table PD-32. SCWF/SIWF 58 - Economizer Full Capacity - 23,200 cfm

Entering Air		Entering Water Temp						
		45 F			55 F			
EDB F	EWB F	Flow gpm	Total MBh	Sensible MBh	LWT F	Total MBh	Sensible MBh	LWT F
	62	145	592.9	536.8	53.2	372.8	372.8	60.1
		174	617.6	547.2	52.1	382.2	382.2	59.4
		186	626.2	550.8	51.7	385.2	385.2	59.1
75	67	145	751.8	454.9	55.4	435.8	337.1	61.0
		174	797.7	473.1	54.2	458.4	345.1	60.3
		186	813.5	479.4	53.7	466.5	348.0	60.0
	72	145	961.6	380.3	58.3	623.9	262.3	63.6
		174	1022.3	402.5	56.8	666.1	276.4	62.7
		186	1043.5	410.3	56.2	680.7	281.3	62.3
80	62	145	651.2	637.7	54.0	465.7	465.7	61.4
		174	670.3	656.9	52.7	477.4	477.4	60.5
		186	676.9	663.4	52.3	481.2	481.2	60.2
	67	145	765.5	580.0	55.6	480.3	472.7	61.6
		174	805.6	595.9	54.3	497.4	478.9	60.7
		186	819.6	601.5	53.8	503.4	481.0	60.4
	72	145	959.5	500.5	58.2	624.4	383.1	63.6
		174	1019.8	523.0	56.7	664.5	396.5	62.6
		186	1040.9	531.0	56.2	678.6	401.3	62.3
85	62	145	740.7	740.7	55.2	558.6	558.6	62.7
		174	759.6	759.6	53.7	572.5	572.5	61.6
		186	765.8	765.8	53.2	577.0	577.0	61.2
	67	145	798.6	712.4	56.0	560.3	560.3	62.7
		174	832.8	726.1	54.6	574.3	574.3	61.6
		186	844.7	730.9	54.1	578.9	578.9	61.2
	72	145	962.1	621.6	58.3	646.7	510.8	63.9
		174	1019.7	643.1	56.7	680.5	522.2	62.8
		186	1039.8	650.7	56.2	692.4	526.2	62.4

Table PD-33. SCWFSIWF 58 - Economizer Low Capacity - 23,200 cfm

Entering Air		Entering Water Temp						
		45 F			55 F			
EDB F	EWB F	Flow gpm	Total MBh	Sensible MBh	LWT F	Total MBh	Sensible MBh	LWT F
	62	145	391.0	377.5	50.4	257.4	257.4	58.6
		174	406.1	398.9	49.7	264.8	264.8	58.0
		186	411.4	401.1	49.4	267.3	267.3	57.9
75	67	145	494.5	321.3	51.8	283.6	245.2	58.9
		174	522.7	331.9	51.0	296.9	249.8	58.4
		186	532.4	335.7	50.7	301.9	251.5	58.2
	72	145	631.6	254.6	53.7	410.1	180.0	60.7
		174	668.7	267.7	52.7	434.7	188.0	60.0
		186	681.6	272.3	52.3	443.2	190.8	59.8
80	62	145	446.6	446.6	51.2	321.8	321.8	59.4
		174	459.8	459.8	50.3	331.0	331.0	58.8
		186	464.3	464.3	50.0	334.1	334.1	58.6
	67	145	498.5	417.6	51.9	322.6	308.1	59.4
		174	523.8	427.2	51.0	332.5	318.0	58.8
		186	532.8	430.6	50.7	336.0	321.4	58.6
	72	145	630.3	349.4	53.7	408.7	275.0	60.6
		174	667.3	362.4	52.7	433.2	282.9	60.0
		186	680.1	367.0	52.3	441.8	285.6	59.8
85	62	145	510.4	510.4	52.0	386.1	386.1	60.3
		174	525.4	525.4	51.0	397.1	397.1	59.6
		186	530.5	530.5	50.7	400.8	400.8	59.3
	67	145	524.8	522.1	52.2	386.8	386.8	60.3
		174	545.5	530.1	51.3	397.9	397.9	59.6
		186	552.8	532.9	50.9	401.6	401.6	59.3
	72	145	628.9	444.0	53.7	419.7	373.6	60.8
		174	665.8	457.0	52.7	439.8	380.2	60.1
		186	678.6	461.5	52.3	447.0	382.5	59.8



Performance Data

Water-Cooled 58 Ton

Table PD-34. SCWF/SIWF 58 Gross Cooling Capacity - 23,200 cfm, 174 gpm

Entering Air		Entering Water Temp								
		75 F			85 F			95 F		
EDB F	EWB F	Total MBh	Sensible MBh	LWT	Total MBh	Sensible MBh	LWT	Total MBh	Sensible MBh	LWT
75	62	663	571	83.9	637	559	93.8	610	547	103.7
	67	720	444	84.6	692	433	94.4	662	421	104.3
	72	782	316	85.3	751	306	95.2	719	294	105.0
80	62	675	674	84.1	653	653	94.0	629	629	103.9
	67	720	564	84.6	692	553	94.4	662	541	104.3
	72	781	436	85.3	751	425	95.2	719	414	105.0
85	62	712	712	84.5	689	689	94.4	665	665	104.3
	67	725	679	84.6	698	666	94.5	669	652	104.4
	72	781	555	85.3	750	545	95.1	718	533	105.0

Chart PD-47. SCWF/SIWF 58 Fan Performance for CV or with VFD

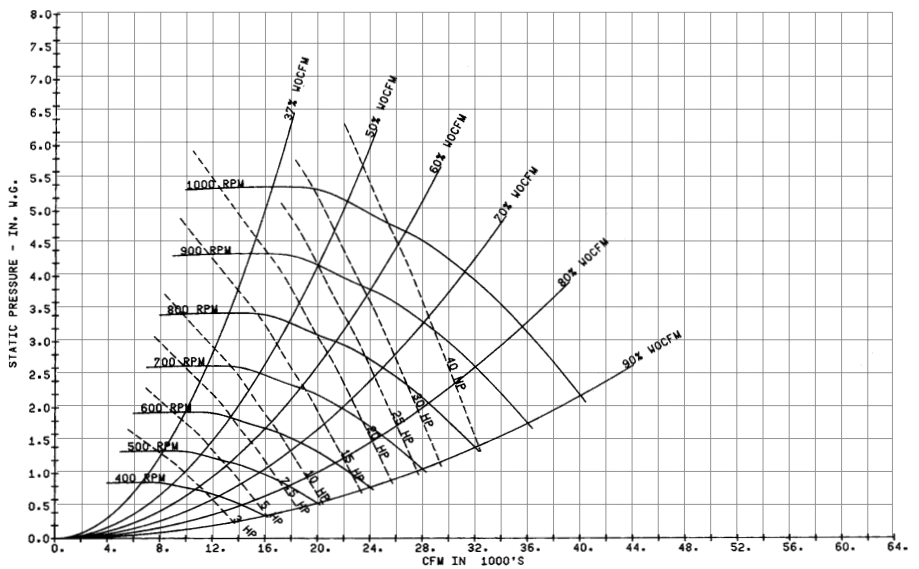
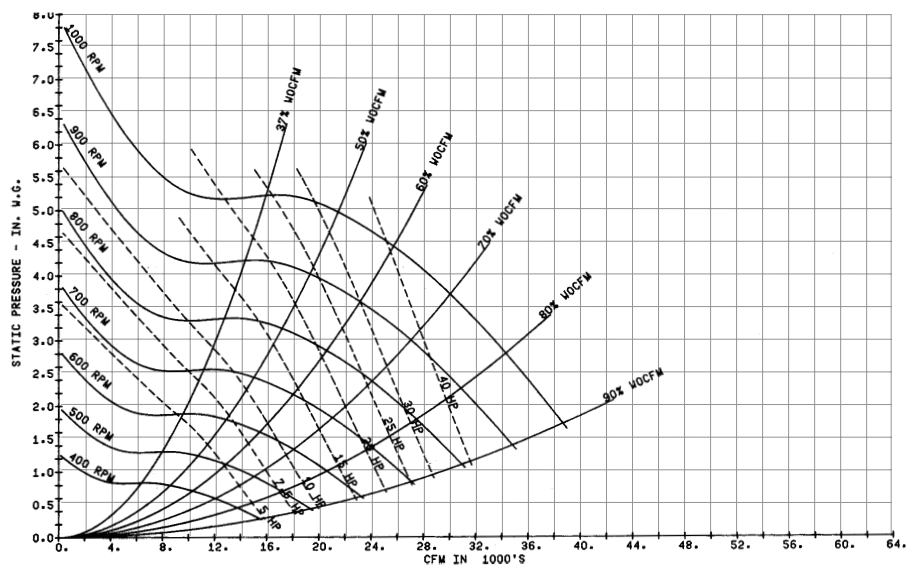

Chart PD-48. SCWF/SIWF 58 Fan Performance with Inlet Guide Vanes



Note:

1. Fan curves include refrigerant coil and internal cabinet static losses. To determine static pressure to be used with these curves, add filter, economizer, flexible horizontal discharge and heat pressure drops to external duct static pressure.



Performance Data

Water-Cooled 65 Ton

Table PD-35. SCWF/SIWF 65 - Economizer Full Capacity - 26,000 cfm

Entering Air		Entering Water Temp							
		45 F			55 F				
EDB F	EWB F	Flow gpm	Total MBh	Sensible MBh	LWT F	Total MBh	Sensible MBh	LWT F	
		163	644.4	590.0	52.9	407.4	407.4	60.0	
		62	195	670.0	600.7	51.9	417.5	417.5	59.3
		226	689.7	609.0	51.1	424.7	424.7	58.8	
75	67	163	815.9	497.6	55.0	472.6	370.1	60.8	
		195	863.7	516.4	53.9	495.9	378.4	60.1	
		226	899.9	530.8	53.0	514.5	385.0	59.6	
	72	163	1043.3	413.8	57.8	676.7	285.8	63.3	
		195	1106.7	436.7	56.4	720.4	300.4	62.4	
		226	1155.0	454.5	55.2	753.5	311.5	61.7	
	62	163	710.6	695.5	53.7	509.0	509.0	61.2	
		195	730.5	715.4	52.5	521.6	521.6	60.3	
		226	745.5	730.4	51.6	530.5	530.5	59.7	
80	67	163	830.6	636.1	55.2	522.6	520.8	61.4	
		195	872.3	652.6	53.9	540.3	527.1	60.5	
		226	904.5	665.4	53.0	553.9	532.0	59.9	
	72	163	1041.0	546.6	57.8	676.9	419.8	63.3	
		195	1104.0	569.9	56.3	718.5	433.6	62.4	
		226	1152.2	588.1	55.2	750.9	444.5	61.6	
	62	163	809.6	809.6	54.9	610.6	610.6	62.5	
		195	829.9	829.9	53.5	625.5	625.5	61.4	
		226	844.4	844.4	52.5	636.1	636.1	60.6	
85	67	163	867.7	783.1	55.6	612.4	612.4	62.5	
		195	903.1	797.2	54.3	627.4	627.4	61.4	
		226	930.4	808.2	53.2	638.2	638.2	60.6	
	72	163	1043.6	680.9	57.8	701.3	561.3	63.6	
		195	1103.6	703.1	56.3	736.1	573.0	62.5	
		226	1149.9	720.5	55.2	763.4	582.1	61.8	

Table PD-36. SCWF/SIWF 65 - Economizer Low Capacity - 26,000 cfm

Entering Air		Entering Water Temp						
		45 F			55 F			
EDB F	EWB F	Flow gpm	Total MBh	Sensible MBh	LWT F	Total MBh	Sensible MBh	LWT F
	62	163	420.9	405.9	50.2	278.1	278.1	58.4
		195	436.1	433.3	49.5	285.8	285.8	57.9
		226	448.0	438.2	49.0	291.4	291.4	57.6
75	67	163	531.1	347.9	51.5	304.3	266.3	58.7
		195	559.7	358.7	50.7	317.8	271.0	58.3
		226	581.7	367.0	50.1	329.0	274.9	57.9
	72	163	678.2	274.0	53.3	440.0	194.2	60.4
		195	715.9	287.3	52.3	464.9	202.3	59.8
		226	744.8	297.6	51.6	484.1	208.5	59.3
	62	163	482.5	482.5	50.9	347.6	347.6	59.3
		195	496.2	496.2	50.1	357.2	357.2	58.7
		226	506.4	506.4	49.5	364.2	364.2	58.2
80	67	163	535.3	453.2	51.6	348.2	348.2	59.3
		195	561.0	463.0	50.8	358.2	342.1	58.7
		226	581.3	470.7	50.1	365.8	349.7	58.2
	72	163	676.7	377.8	53.3	438.6	298.1	60.4
		195	714.3	391.0	52.3	463.4	306.1	59.8
		226	743.2	401.3	51.6	482.5	312.3	59.3
	62	163	551.5	551.5	51.8	417.1	417.1	60.1
		195	567.1	567.1	50.8	428.5	428.5	59.4
		226	578.6	578.6	50.1	436.9	436.9	58.9
85	67	163	564.7	547.6	51.9	417.9	417.9	60.1
		195	585.6	575.9	51.0	429.3	429.3	59.4
		226	602.0	582.2	50.3	437.7	437.7	58.9
	72	163	675.3	481.4	53.3	450.5	406.1	60.5
		195	712.8	494.6	52.3	470.8	412.7	59.8
		226	741.5	504.8	51.6	486.9	417.9	59.3

Performance Data

Water-Cooled 65 Ton

Table PD-37. SCWF/SIWF 65 Gross Cooling Capacity - 26,000 cfm, 196 gpm

Entering Air		Entering Water Temp								
		75 F			85 F			95 F		
EDB F	EWB F	Total MBh	Sensible MBh	LWT	Total MBh	Sensible MBh	LWT	Total MBh	Sensible MBh	LWT
75	62	744	609	84.1	715	597	93.9	686	583	103.8
	67	809	480	84.8	779	468	94.6	746	455	104.5
	72	879	351	85.5	845	338	95.4	810	326	105.2
80	62	749	726	84.1	722	711	94.0	694	692	104.0
	67	809	601	84.8	778	589	94.6	746	576	104.5
	72	878	471	85.5	844	459	95.4	810	447	105.2
85	62	780	780	84.5	756	756	94.4	730	730	104.4
	67	809	721	84.8	779	708	94.6	747	695	104.5
	72	877	592	85.5	844	579	95.4	808	567	105.2

Chart PD-49. SCWF/SIWF 65 Fan Performance for CV or with VFD

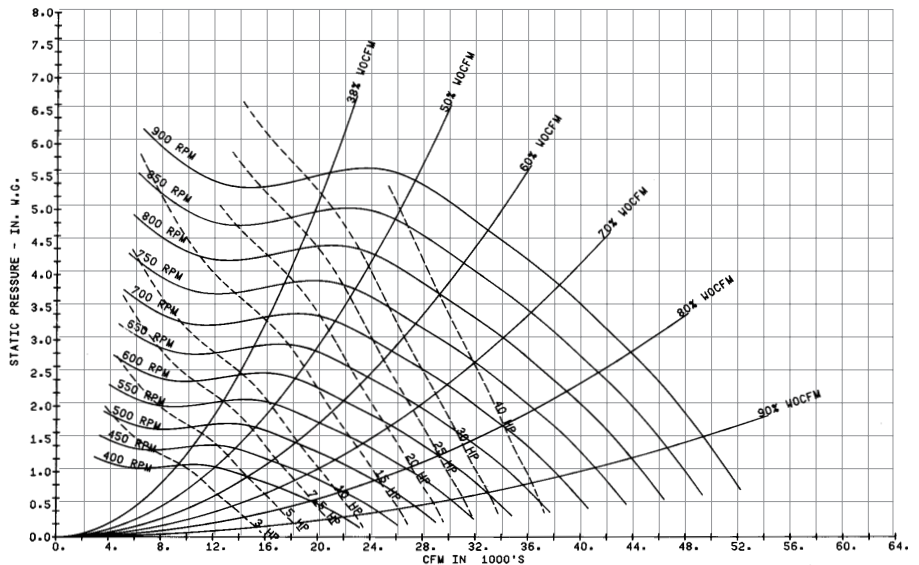
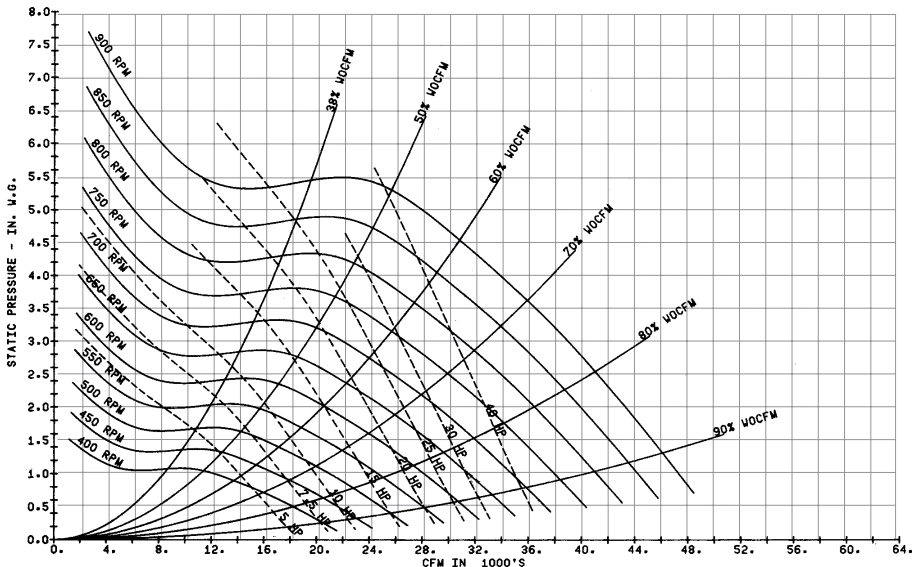

Chart PD-50. SCWF/SIWF 65 Fan Performance with Inlet Guide Vanes



Note:

1. Fan curves include refrigerant coil and internal cabinet static losses. To determine static pressure to be used with these curves, add filter, economizer, flexible horizontal discharge and heat pressure drops to external duct static pressure.



Performance Data

Water-Cooled 72 Ton

Table PD-38. SCWF/SIWF 72 - Economizer Full Capacity - 28,000 cfm

Entering Air		Entering Water Temp						
		45 F			55 F			
EDB F	EWB F	Flow gpm	Total MBh	Sensible MBh	LWT F	Total MBh	Sensible MBh	LWT F
75	62	180	692.2	640.9	52.7	440.0	440.0	59.9
		216	719.4	652.3	51.7	451.1	451.1	59.2
		226	725.9	655.0	51.4	453.6	453.6	59.0
	67	180	874.7	537.8	54.7	506.6	401.7	60.6
		216	925.8	557.8	53.6	531.1	410.4	59.9
		226	937.7	562.5	53.3	537.2	412.5	59.8
80	72	180	1117.6	443.9	57.4	724.9	307.7	63.1
		216	1185.9	469.3	56.0	771.3	323.1	62.1
		226	1201.8	475.0	55.6	782.2	326.7	61.9
	62	180	766.5	749.8	53.5	549.8	549.8	61.1
		216	787.8	771.1	52.3	563.5	563.5	60.2
		226	792.8	776.1	52.0	566.6	566.6	60.0
67	180	890.5	689.6	54.9	562.1	542.9	61.2	
	216	934.9	707.0	53.7	580.8	573.8	60.4	
	226	945.5	711.2	53.4	585.3	575.4	60.2	
85	72	180	1114.9	589.6	57.4	724.9	454.5	63.1
		216	1183.0	614.7	56.0	769.1	469.2	62.1
		226	1198.9	620.6	55.6	779.7	472.7	61.9
	62	180	874.4	874.4	54.7	659.4	659.4	62.3
		216	896.7	896.7	53.3	675.8	675.8	61.3
		226	901.7	901.7	53.0	679.5	679.5	61.0
67	180	931.6	850.8	55.4	661.3	661.3	62.3	
	216	969.2	865.7	54.0	677.8	677.8	61.3	
	226	978.2	869.3	53.7	681.6	681.6	61.0	
72	180	1118.3	737.1	57.4	751.4	609.6	63.3	
	216	1182.3	760.6	55.9	788.3	621.9	62.3	
	226	1197.5	766.2	55.6	797.1	624.8	62.1	

Table PD-39. SCWF/SIWF 72 - Economizer Low Capacity - 28,000 cfm

Entering Air		Entering Water Temp						
		45 F			55 F			
EDB F	EWB F	Flow gpm	Total MBh	Sensible MBh	LWT F	Total MBh	Sensible MBh	LWT F
75	62	180	448.3	431.7	50.0	297.1	297.1	58.3
		216	464.1	447.5	49.3	305.3	305.3	57.8
		226	467.9	467.4	49.1	307.1	307.1	57.7
	67	180	564.0	372.5	51.3	323.1	286.1	58.6
		216	593.9	383.7	50.5	337.1	291.0	58.1
		226	601.0	386.4	50.3	340.6	292.2	58.0
80	72	180	720.0	291.7	53.0	466.8	207.2	60.2
		216	759.4	305.5	52.0	492.8	215.6	59.6
		226	768.7	308.8	51.8	499.0	217.5	59.4
	62	180	515.6	515.6	50.7	371.4	371.4	59.1
		216	530.2	530.2	49.9	381.5	381.5	58.5
		226	533.5	533.5	49.7	383.9	383.9	58.4
67	180	568.5	486.6	51.3	372.0	372.0	59.1	
	216	595.3	496.7	50.5	382.2	364.5	58.5	
	226	601.8	499.1	50.3	384.7	366.9	58.4	
85	72	180	718.5	404.1	53.0	465.3	319.7	60.2
		216	757.7	417.8	52.0	491.2	328.0	59.5
		226	767.0	421.1	51.8	497.3	330.0	59.4
	62	180	589.3	589.3	51.5	445.6	445.6	60.0
		216	605.9	605.9	50.6	457.8	457.8	59.2
		226	609.7	609.7	50.4	460.6	460.6	59.1
67	180	601.1	582.4	51.7	446.4	446.4	60.0	
	216	622.8	619.2	50.8	458.6	458.6	59.2	
	226	628.0	621.2	50.6	461.4	461.4	59.1	
72	180	716.9	516.2	53.0	478.3	436.6	60.3	
	216	756.1	529.9	52.0	499.3	443.4	59.6	
	226	765.4	533.2	51.8	504.4	445.1	59.5	

Performance Data

Water-Cooled 72 Ton

Table PD-40. SCWF/SIWF 72 Gross Cooling Capacity - 28,800 cfm, 216 gpm

Entering Air		Entering Water Temp								
		75 F			85 F			95 F		
EDB F	EWB F	Total MBh	Sensible MBh	LWT	Total MBh	Sensible MBh	LWT	Total MBh	Sensible MBh	LWT
75	62	799	690	83.7	768	675	93.6	735	660	103.4
	67	868	536	84.3	834	522	94.2	798	509	104.0
	72	941	381	85.0	905	368	94.9	866	355	104.7
80	62	814	812	83.8	787	788	93.7	758	758	103.7
	67	868	681	84.3	833	668	94.2	798	653	104.0
	72	941	526	85.0	904	514	94.8	866	500	104.7
85	62	859	859	84.2	832	832	94.2	802	802	104.1
	67	874	819	84.4	841	803	94.3	807	786	104.1
	72	940	670	85.0	904	658	94.8	865	644	104.7

Chart PD-51. SCWF/SIWF 72 Fan Performance for CV or with VFD

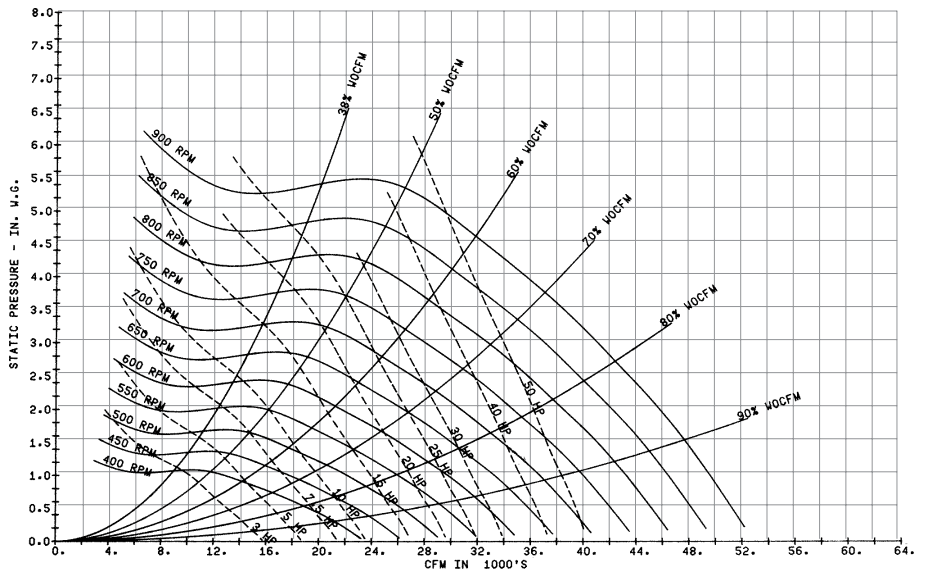
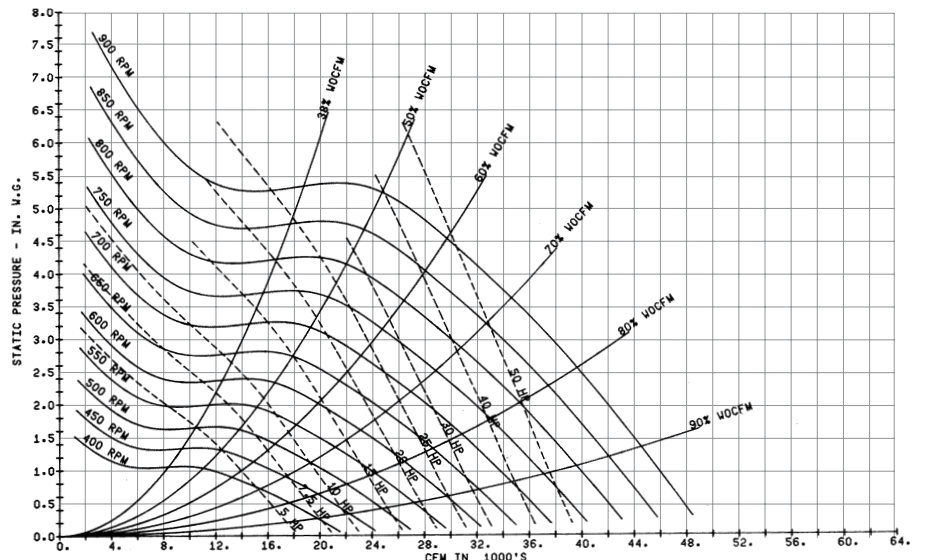

Chart PD-52. SCWF/SIWF 72 Fan Performance with Inlet Guide Vanes



Note:

1. Fan curves include refrigerant coil and internal cabinet static losses. To determine static pressure to be used with these curves, add filter, economizer, flexible horizontal discharge and heat pressure drops to external duct static pressure.



Performance Data

Water-Cooled 80 Ton

Table PD-41. SCWF/SIWF 80 - Economizer Full Capacity - 29,800 cfm

Entering Air		Entering Water Temp							
		45 F			55 F				
EDB F	EWB F	Flow gpm	Total MBh	Sensible MBh	LWT F	Total MBh	Sensible MBh	LWT F	
75	62	200	719.8	663.3	52.2	456.0	456.0	59.6	
		240	746.6	674.5	51.2	466.7	466.7	58.9	
		248	751.3	676.5	51.1	468.4	468.4	58.8	
	67	200	240	915.9	559.9	54.2	527.8	416.0	60.3
			240	966.0	579.6	53.1	552.8	424.9	59.6
			248	974.5	583.0	52.9	557.1	426.4	59.5
		72	200	1171.5	464.7	56.7	760.6	321.6	62.6
			240	1238.3	489.6	55.3	805.9	336.7	61.7
			248	1249.7	493.8	55.1	813.6	339.3	61.6
80	62	200	794.7	777.5	52.9	569.7	569.7	60.7	
		240	815.5	798.2	51.8	583.0	583.0	59.9	
		248	819.0	801.7	51.6	585.1	585.1	59.7	
	67	200	240	929.2	715.3	54.3	583.4	563.2	60.8
			240	973.1	732.5	53.1	601.8	592.6	60.0
			248	980.7	735.5	52.9	605.0	593.8	59.9
		72	200	1168.7	614.9	56.7	759.4	472.5	62.6
			240	1235.3	639.5	55.3	803.2	487.1	61.7
			248	1246.6	643.7	55.1	810.8	489.6	61.5
85	62	200	906.2	906.2	54.1	683.3	683.3	61.8	
		240	927.8	927.8	52.7	699.1	699.1	60.8	
		248	931.3	931.3	52.5	701.7	701.7	60.7	
	67	200	240	969.0	880.5	54.7	685.2	685.2	61.9
			240	1006.1	895.3	53.4	701.2	701.2	60.8
			248	1012.5	897.8	53.2	703.8	703.8	60.7
		72	200	1170.1	766.1	56.7	783.6	631.4	62.8
			240	1233.4	789.5	55.3	820.2	643.6	61.8
			248	1244.3	793.5	55.0	826.5	645.7	61.7

Table PD-42. SCWF/SIWF 80 - Economizer Low Capacity - 29,800 cfm

Entering Air		Entering Water Temp							
		45 F			55 F				
EDB F	EWB F	Flow gpm	Total MBh	Sensible MBh	LWT F	Total MBh	Sensible MBh	LWT F	
75	62	200	464.0	446.9	49.6	307.0	307.0	58.1	
		240	479.5	462.3	49.0	314.9	314.9	57.6	
		248	482.2	480.6	48.9	316.2	316.2	57.6	
	67	200	240	587.4	385.5	50.9	334.7	294.7	58.3
			240	616.7	396.5	50.1	349.2	299.7	57.9
			248	621.7	398.4	50.0	351.7	300.6	57.8
		72	200	750.3	303.3	52.5	486.5	215.0	59.9
			240	788.8	316.9	51.6	511.9	223.2	59.3
			248	795.4	319.2	51.4	516.3	224.6	59.2
80	62	200	533.0	533.0	50.3	383.7	383.7	58.8	
		240	547.1	547.1	49.6	393.5	393.5	58.3	
		248	549.4	549.4	49.4	395.2	395.2	58.2	
	67	200	240	590.6	502.1	50.9	384.4	384.4	58.8
			240	617.2	512.1	50.1	394.3	375.9	58.3
			248	621.8	513.9	50.0	396.0	377.7	58.2
		72	200	748.7	418.7	52.5	484.9	330.5	59.8
			240	787.1	432.2	51.6	510.2	338.7	59.3
			248	793.7	434.5	51.4	514.6	340.1	59.1
85	62	200	609.1	609.1	51.1	460.4	460.4	59.6	
		240	625.1	625.1	50.2	472.2	472.2	58.9	
		248	627.8	627.8	50.1	474.1	474.1	58.8	
	67	200	240	622.3	602.9	51.2	461.2	461.2	59.6
			240	643.6	637.3	50.4	473.0	473.0	58.9
			248	647.3	638.7	50.2	475.0	475.0	58.8
		72	200	747.1	533.8	52.5	496.6	450.0	60.0
			240	785.4	547.2	51.5	517.0	456.6	59.3
			248	791.9	549.5	51.4	520.6	457.8	59.2

Performance Data

Water-Cooled 80 Ton

Table PD-43. SCWF/SIWF 80 Gross Cooling Capacity - 29,800 cfm, 240 gpm

Entering Air		Entering Water Temp								
		75 F			85 F			95 F		
EDB F	EWB F	Total MBh	Sensible MBh	LWT	Total MBh	Sensible MBh	LWT	Total MBh	Sensible MBh	LWT
75	62	891	761	83.7	856	746	93.6	819	729	103.4
	67	966	590	84.3	928	575	94.2	887	559	104.0
	72	1049	419	85.0	1007	405	94.8	963	389	104.7
80	62	910	896	83.8	880	867	93.8	847	834	103.7
	67	967	752	84.3	929	737	94.2	888	721	104.0
	72	1048	579	85.0	1006	565	94.8	963	550	104.7
85	62	961	947	84.3	930	916	94.2	896	883	104.1
	67	975	908	84.4	938	890	94.3	899	871	104.1
	72	1047	740	85.0	1006	725	94.8	963	710	104.7

Chart PD-53. SCWF/SIWF 80 Fan Performance for CV or with VFD

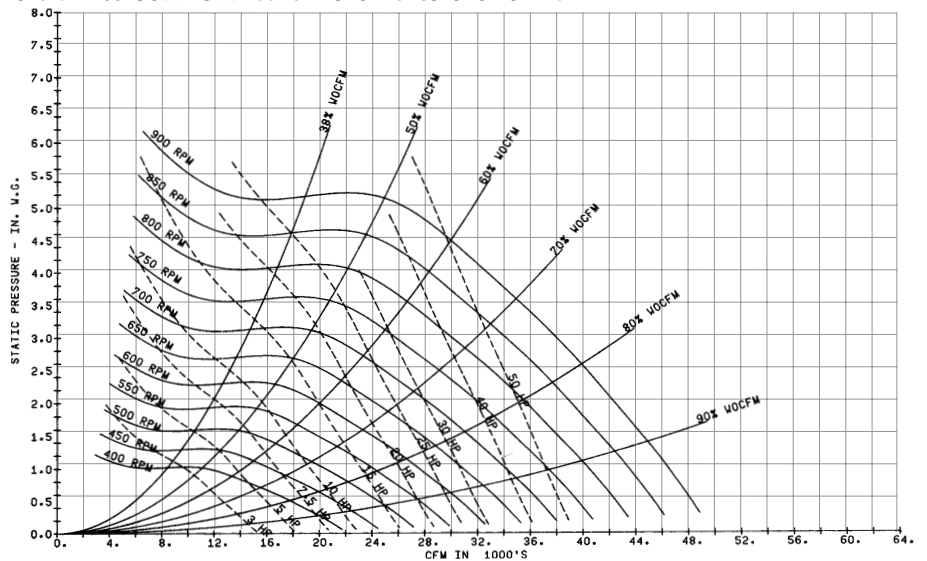
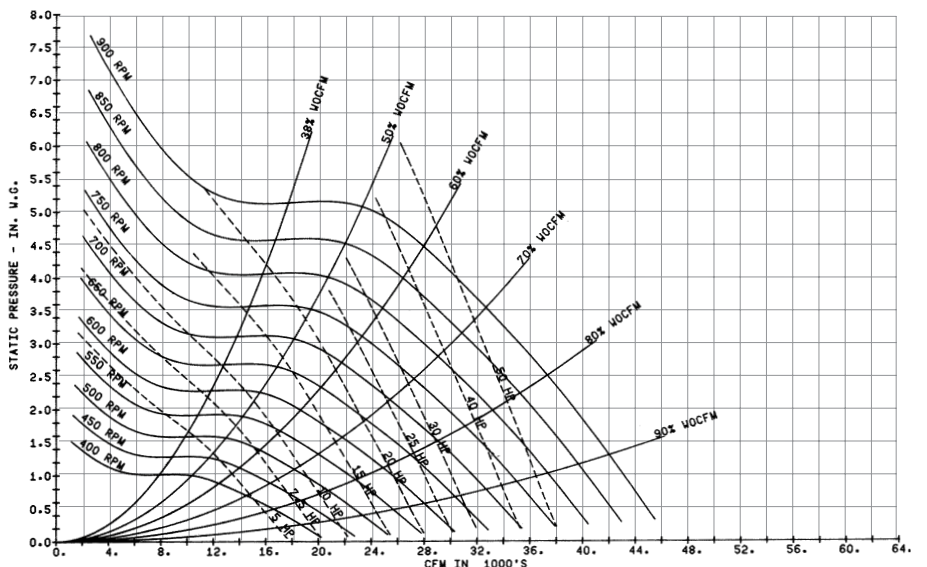

Chart PD-54. SCWF/SIWF 80 Fan Performance with Inlet Guide Vanes



Note:

1. Fan curves include refrigerant coil and internal cabinet static losses. To determine static pressure to be used with these curves, add filter, economizer, flexible horizontal discharge and heat pressure drops to external duct static pressure.



Performance Data

Air-Cooled 20 Ton

Table PD-44. SCRF/SIRF 20 Gross Cooling Capacity - 10,000 cfm - Air Cooled

		Entering Ambient Air Temperature									
		75 F		85 F		95 F		105 F		115 F	
EDB F	EWB F	Tot MBh	Sen MBh	Tot MBh	Sen MBh	Tot MBh	Sen MBh	Tot MBh	Sen MBh	Tot MBh	Sen MBh
70	62	287.5	191.1	277.4	186.6	266.5	181.9	255.0	176.9	242.6	171.7
	67	313.6	139.5	302.6	135.2	290.9	130.6	278.4	125.7	265.1	120.6
75	62	287.3	240.4	277.4	235.9	266.8	231.1	255.4	226.0	243.4	220.5
	67	313.3	188.7	302.4	184.3	290.7	179.7	278.2	174.8	264.9	169.7
80	62	291.4	286.6	282.3	280.6	272.9	273.1	263.2	263.3	252.7	252.7
	67	313.1	237.6	302.1	233.2	290.4	228.6	278.0	223.7	264.8	218.5
85	62	306.9	306.9	298.1	298.2	288.7	288.7	278.5	278.6	267.6	267.7
	67	314.5	285.8	303.9	281.1	292.7	275.9	280.9	270.2	268.5	263.6
	72	340.5	234.2	328.6	229.9	316.0	225.3	302.5	220.5	288.2	215.5

Chart PD-55. SCRF/SIRF 20 Fan Performance for CV or with VFD

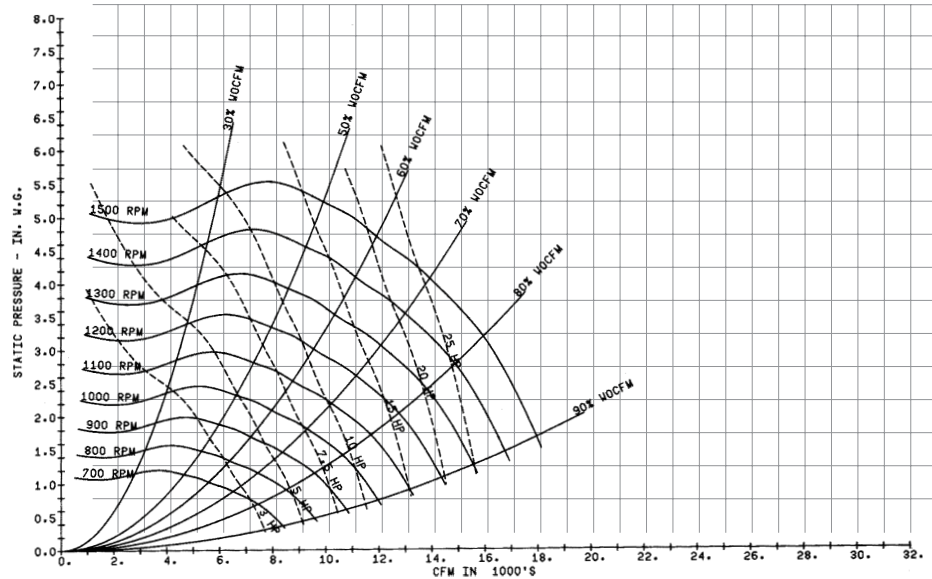
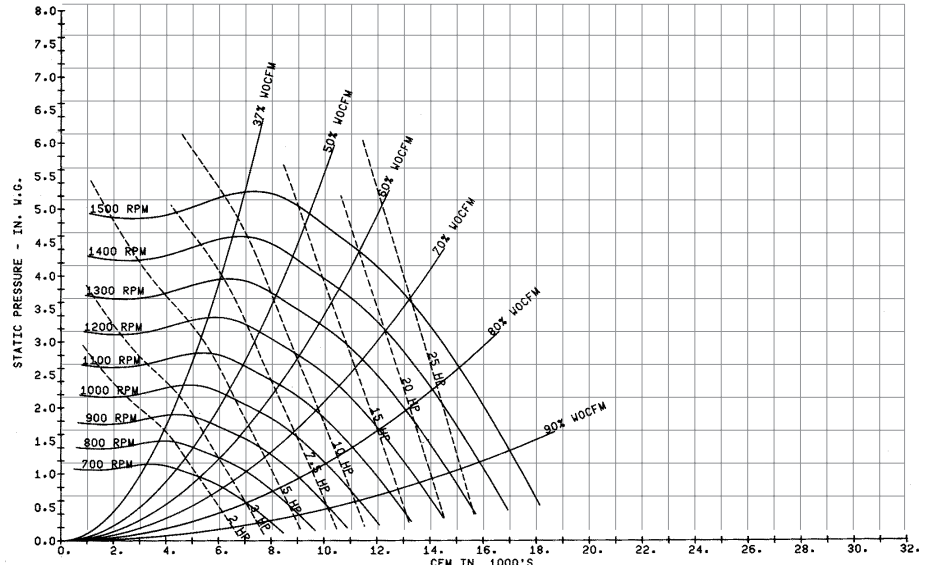

Chart PD-56. SCRF/SIRF 20 Fan Performance with Inlet Guide Vanes



Note:
1. Fan curves include refrigerant coil and internal cabinet static losses. To determine static pressure to be used with these curves, add filter, economizer, flexible horizontal discharge and heat pressure drops to external duct static pressure.



Performance Data

Air-Cooled 25 Ton

Table PD-45. SCRF/SIRF 25 Gross Cooling Capacity - 11,600 cfm

		Entering Ambient Air Temperature									
		75 F		85 F		95 F		105 F		115 F	
EDB F	EWB F	Tot MBh	Sen MBh	Tot MBh	Sen MBh	Tot MBh	Sen MBh	Tot MBh	Sen MBh	Tot MBh	Sen MBh
70	62	336.8	214.8	325.2	209.5	312.8	204.0	299.6	198.1	285.7	192.0
	67	367.8	161.8	355.1	156.6	341.7	151.1	327.5	145.5	312.4	139.5
75	62	336.5	265.4	324.9	260.1	312.5	254.5	299.4	248.7	285.5	242.5
	67	367.4	212.3	354.8	207.1	341.4	201.6	327.2	195.9	312.1	189.9
	72	400.2	158.7	386.5	153.6	372.0	148.3	356.6	142.8	340.3	137.0
80	62	337.8	315.3	326.7	309.5	315.1	303.1	303.0	296.0	290.7	287.2
	67	367.1	262.6	354.5	257.3	341.1	251.8	326.9	246.1	311.9	240.0
	72	399.9	208.8	386.2	203.7	371.7	198.4	356.3	192.8	340.0	187.0
85	62	349.9	350.0	340.3	340.4	329.9	329.9	318.7	318.7	306.7	306.8
	67	366.9	312.6	354.5	307.3	341.3	301.6	327.4	295.6	312.9	289.1
	72	399.6	258.8	385.9	253.6	371.3	248.2	356.0	242.6	339.8	236.7

Chart PD-57. SCRF/SIRF 25 Fan Performance for CV or with VFD

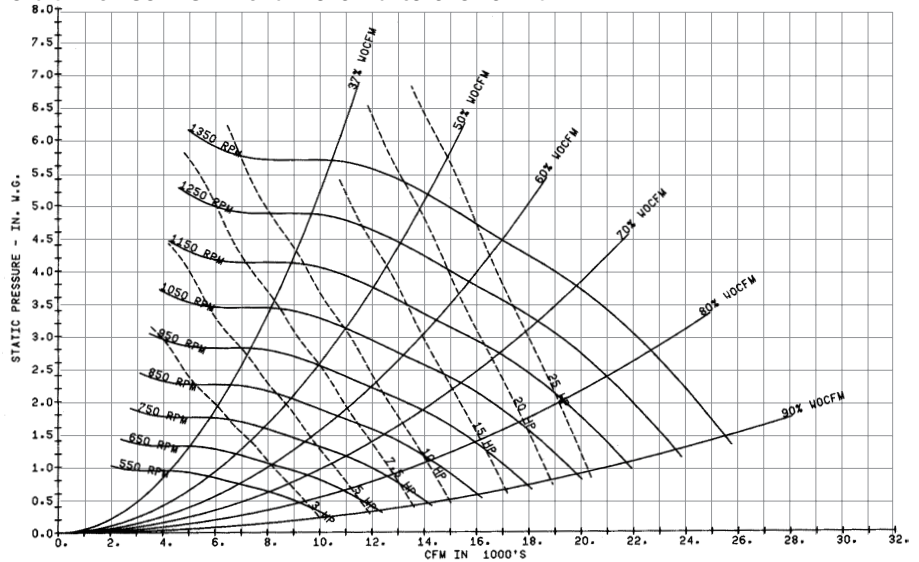
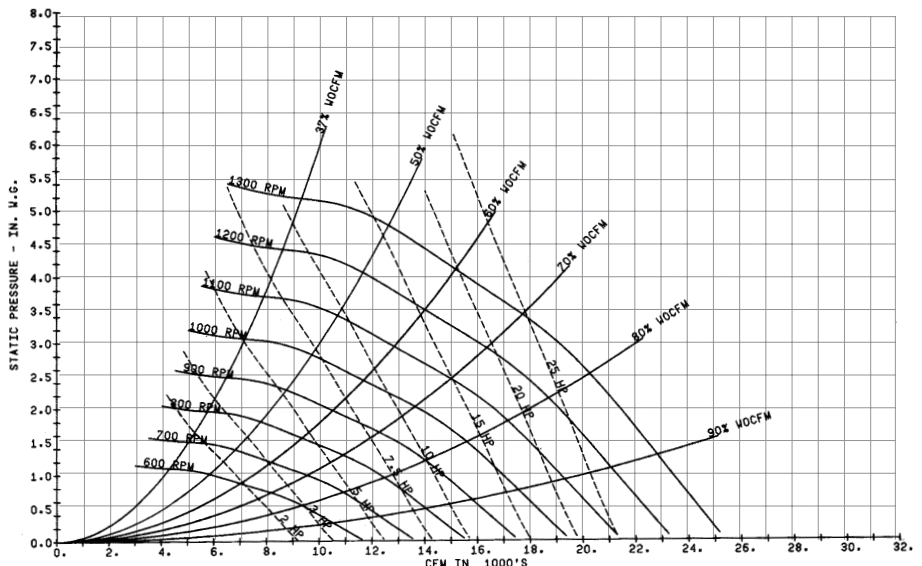

Chart PD-58. SCRF/SIRF 25 Fan Performance with Inlet Guide Vanes



Note:

1. Fan curves include refrigerant coil and internal cabinet static losses. To determine static pressure to be used with these curves, add filter, economizer, flexible horizontal and heat discharge pressure drops to external duct static pressure.



Performance Data

Air-Cooled 29 Ton

Table PD-46. SCRF/SIRF 29 Gross Cooling Capacity - 12,800 cfm

		Entering Ambient Air Temperature									
		75 F		85 F		95 F		105 F		115 F	
EDB F	EWB F	Tot MBh	Sen MBh	Tot MBh	Sen MBh	Tot MBh	Sen MBh	Tot MBh	Sen MBh	Tot MBh	Sen MBh
70	62	370.7	252.4	356.6	246.3	341.7	239.9	326.1	233.2	309.7	226.3
	67	404.3	181.4	388.9	175.4	372.8	169.2	355.9	162.7	338.2	156.0
75	62	371.5	320.3	357.6	314.0	343.0	307.3	327.8	300.3	311.9	292.7
	67	403.9	249.1	388.6	243.1	372.5	236.9	355.6	230.3	337.9	223.6
80	62	379.9	377.1	367.4	366.5	354.5	354.6	341.1	341.1	326.8	326.8
	67	403.9	316.7	388.8	310.6	372.8	304.2	356.1	297.5	338.7	290.5
85	62	400.8	400.9	388.3	388.4	375.1	375.2	361.1	361.1	346.3	346.3
	67	407.3	382.3	392.7	375.3	377.6	367.3	362.5	356.6	346.8	344.2
	72	438.8	312.0	422.2	306.0	404.8	299.9	386.7	293.4	367.7	286.8

Chart PD-59. SCRF/SIRF 29 Fan Performance for CV or with VFD

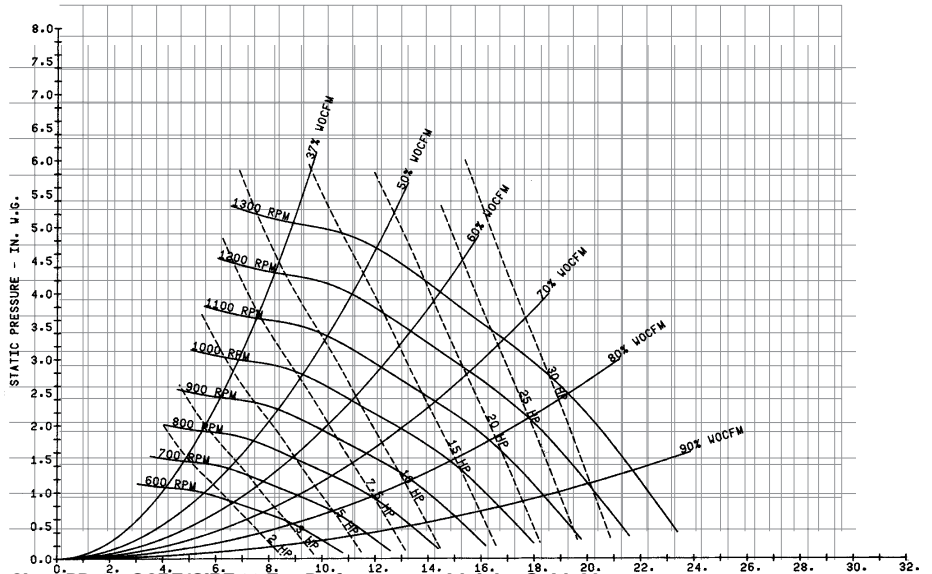
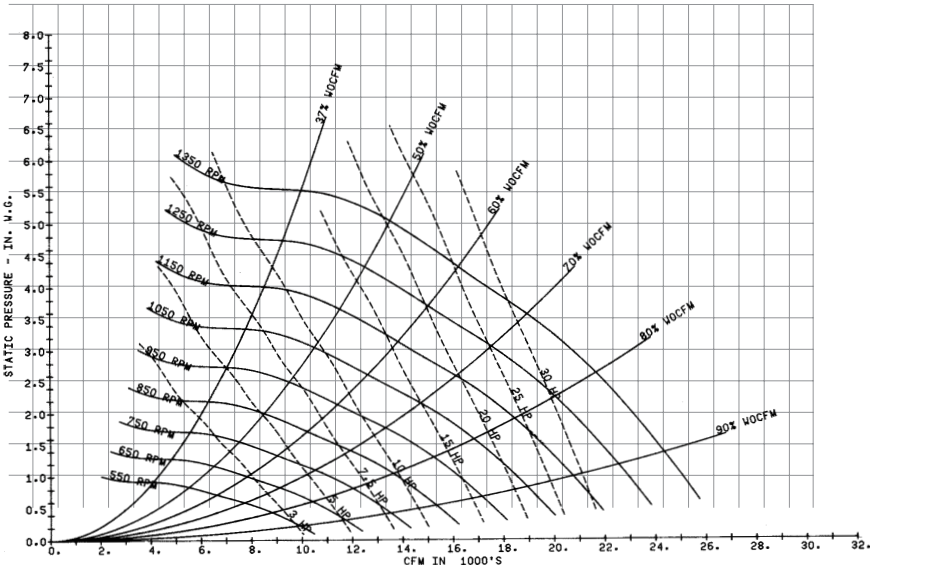

Chart PD-60. SCRF/SIRF 29 Fan Performance with Inlet Guide Vanes



Note:
 1. Fan curves include refrigerant coil and internal cabinet static losses. To determine static pressure to be used with these curves, add filter, economizer, flexible horizontal discharge and heat pressure drops to external duct static pressure.



Performance Data

Air-Cooled 30 Ton

Table PD-47. SCRF/SIRF 30 Gross Cooling Capacity - 14,000 cfm

		Entering Ambient Air Temperature									
		75 F		85 F		95 F		105 F		115 F	
EDB F	EWB F	Tot MBh	Sen MBh	Tot MBh	Sen MBh	Tot MBh	Sen MBh	Tot MBh	Sen MBh	Tot MBh	Sen MBh
70	62	415.4	268.4	401.2	262.0	386.0	255.3	369.6	248.1	352.1	240.5
	67	453.3	200.0	437.9	193.7	421.4	187.1	403.8	180.2	384.9	172.8
75	62	415.0	333.7	400.9	327.3	385.6	320.5	369.3	313.3	352.0	305.6
	67	452.9	265.1	437.6	258.9	421.1	252.2	403.4	245.2	384.6	237.8
80	62	417.7	397.5	404.4	390.3	390.2	382.3	375.4	372.9	360.4	360.8
	67	452.6	330.0	437.2	323.7	420.7	317.0	403.1	309.9	384.3	302.4
85	62	435.7	435.8	423.7	423.7	410.7	410.7	396.7	396.7	381.6	381.6
	67	452.7	394.5	437.7	388.0	421.7	381.1	404.7	373.5	386.7	365.2
	72	492.5	325.2	475.8	319.0	458.0	312.5	438.9	305.6	418.7	298.3

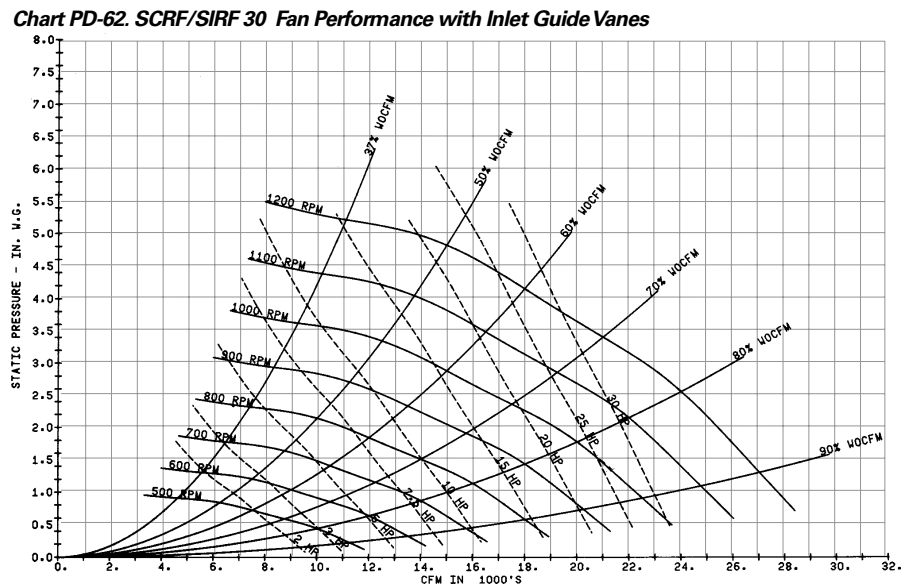
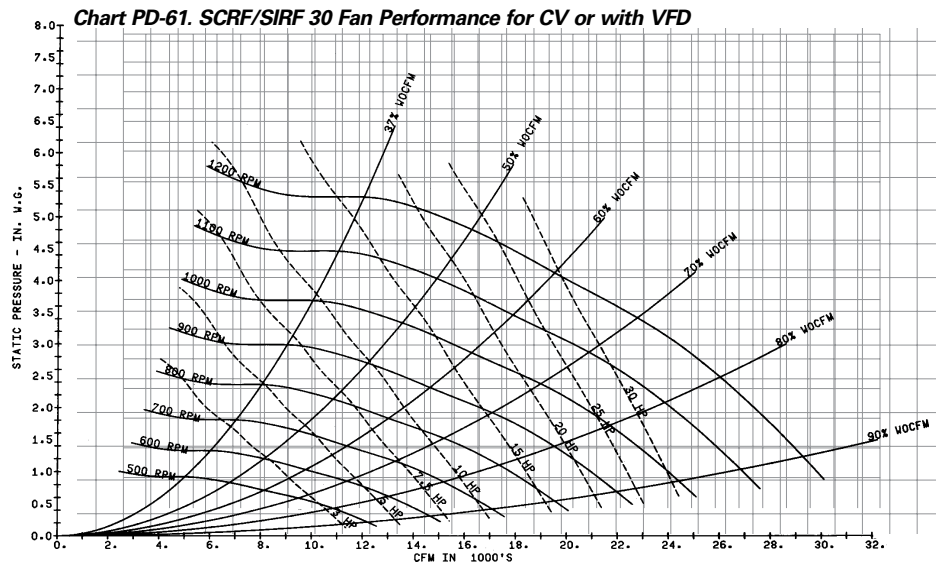

Note:
 1. Fan curves include refrigerant coil and internal cabinet static losses. To determine static pressure to be used with these curves, add filter, economizer, flexible horizontal discharge and heat pressure drops to external duct static pressure.



Performance Data

Air-Cooled 35 Ton

Table PD-48. SCRF/SIRF 35 Gross Cooling Capacity - 15,200 cfm

		Entering Ambient Air Temperature									
		75 F		85 F		95 F		105 F		115 F	
EDB F	EWB F	Tot MBh	Sen MBh	Tot MBh	Sen MBh	Tot MBh	Sen MBh	Tot MBh	Sen MBh	Tot MBh	Sen MBh
70	62	440.9	298.8	424.9	291.9	407.8	284.5	389.6	276.8	370.3	268.6
	67	480.9	215.4	463.5	208.6	445.0	201.4	425.4	193.9	404.5	186.0
75	62	441.7	378.7	425.9	371.6	409.1	364.0	391.4	355.9	372.6	347.1
	67	480.6	295.0	463.2	288.2	444.7	281.0	425.0	273.4	404.2	265.4
80	62	450.4	450.2	436.9	437.0	422.3	422.4	406.7	406.7	389.9	390.0
	67	480.4	374.5	463.2	367.6	444.9	360.2	425.5	352.5	405.0	344.3
85	62	476.1	476.2	462.0	462.1	446.9	446.9	430.7	430.7	413.3	413.3
	67	484.2	451.9	467.5	444.2	450.0	435.8	431.7	426.0	413.2	413.3
	72	522.3	369.0	503.4	362.2	483.4	355.1	462.3	347.7	440.1	339.8

Chart PD-63. SCRF/SIRF 35 Fan Performance for CV or with VFD

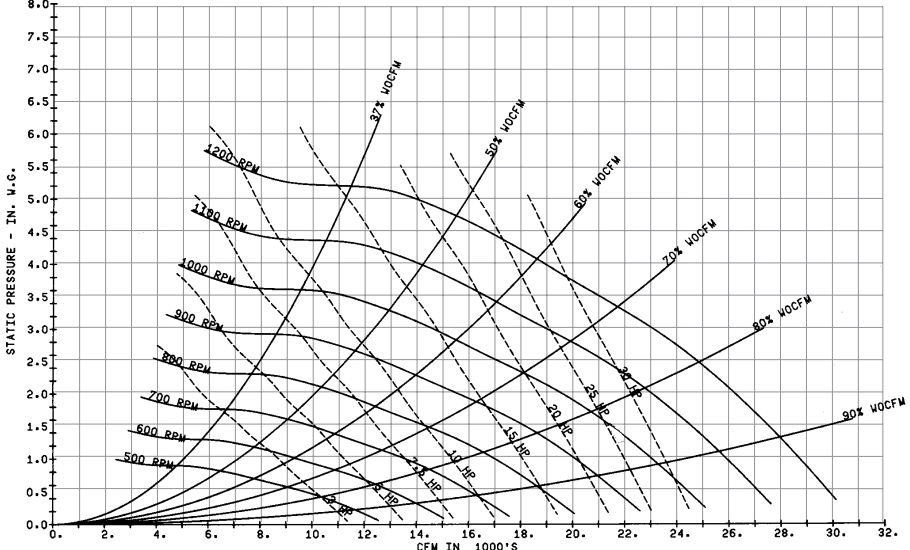
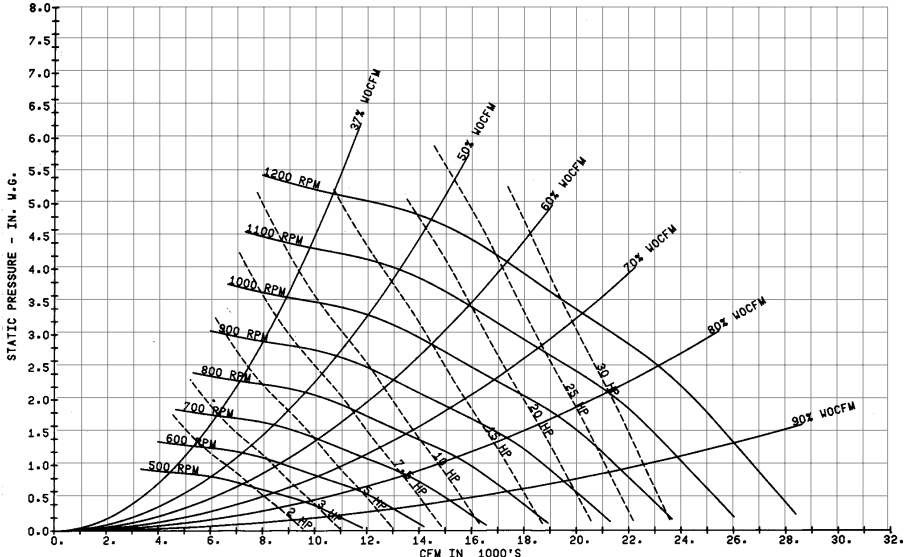

Chart PD-64. SCRF/SIRF 35 Fan Performance with Inlet Guide Vanes



Note:
1. Fan curves include refrigerant coil and internal cabinet static losses. To determine static pressure to be used with these curves, add filter, economizer, flexible horizontal discharge and heat pressure drops to external duct static pressure.



Performance Data

Air-Cooled 40 Ton

Table PD-49. SCRF/SIRF 40 Gross Cooling Capacity - 18,400 cfm

		Entering Ambient Air Temperature									
		75 F		85 F		95 F		105 F		115 F	
EDB F	EWB F	Tot MBh	Sen MBh	Tot MBh	Sen MBh	Tot MBh	Sen MBh	Tot MBh	Sen MBh	Tot MBh	Sen MBh
70	62	512.1	343.9	493.5	335.8	473.8	327.2	452.9	318.3	430.8	308.9
	67	559.2	249.9	539.0	241.9	517.6	233.6	495.0	224.8	471.1	215.7
75	62	512.3	434.1	494.0	425.8	474.6	417.0	454.1	407.6	432.6	397.5
	67	558.7	339.8	538.5	331.8	517.2	323.4	494.6	314.6	470.7	305.4
72	62	608.7	245.2	586.8	237.4	563.6	229.2	539.0	220.7	513.2	211.8
	67	608.2	334.4	586.3	326.6	563.1	318.4	538.6	309.8	512.8	300.8
80	62	522.3	509.6	505.7	496.5	488.0	482.5	469.3	467.3	449.8	450.1
	67	558.2	429.4	538.1	421.3	516.9	412.9	494.5	404.0	470.9	394.6
72	62	608.2	334.4	586.3	326.6	563.1	318.4	538.6	309.8	512.8	300.8
	67	548.1	548.2	532.0	532.0	514.7	514.8	496.2	496.3	476.6	476.6
85	62	561.3	516.7	542.0	507.6	521.9	497.2	501.4	483.4	480.1	467.3
	72	607.7	423.4	585.8	415.5	562.6	407.2	538.1	398.5	512.4	389.5

Chart PD-65. SCRF/SIRF 40 Fan Performance for CV or with VFD

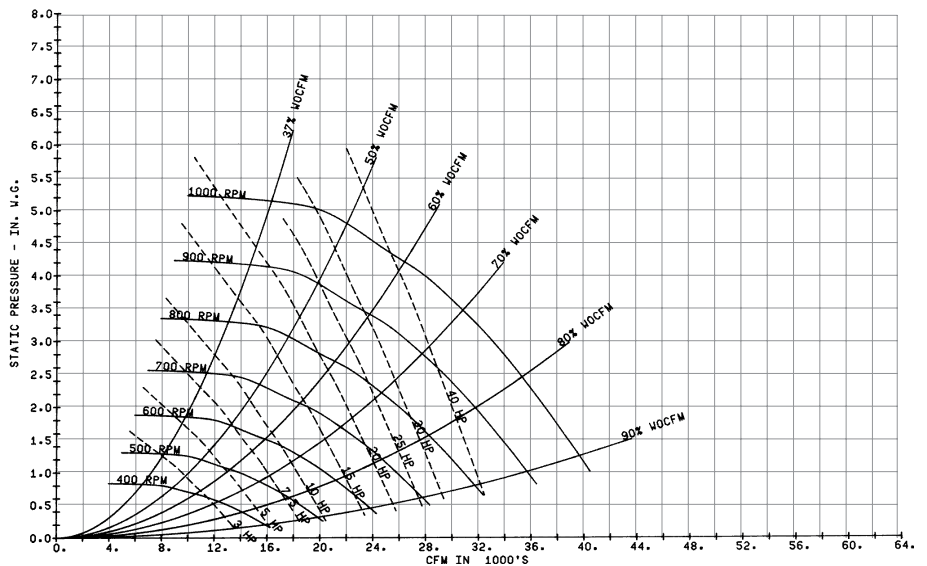
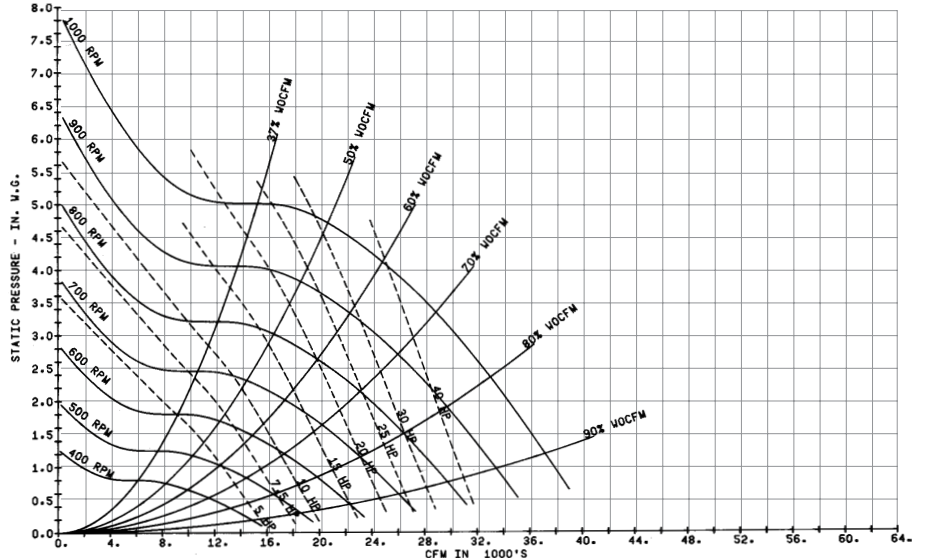

Chart PD-66. SCRF/SIRF 40 Fan Performance with Inlet Guide Vanes



Note:
1. Fan curves include refrigerant coil and internal cabinet static losses. To determine static pressure to be used with these curves, add filter, economizer, flexible horizontal discharge and heat pressure drops to external duct static pressure.



Performance Data

Air-Cooled 50 Ton

Table PD-50. SCRF/SIRF 50 Gross Cooling Capacity - 23,200 cfm

		Entering Ambient Air Temperature									
		75 F		85 F		95 F		105 F		115 F	
EDB F	EWB F	Tot MBh	Sen MBh	Tot MBh	Sen MBh	Tot MBh	Sen MBh	Tot MBh	Sen MBh	Tot MBh	Sen MBh
70	62	658.4	438.9	633.9	428.2	608.4	417.1	581.6	405.6	553.7	393.7
	67	719.0	320.1	692.5	309.7	664.9	298.9	636.0	287.7	605.8	276.2
75	62	657.8	552.9	633.5	542.1	608.4	531.0	582.2	519.4	555.0	507.1
	67	718.4	433.7	692.0	423.2	664.3	412.3	635.4	401.1	605.3	389.4
80	62	667.2	660.8	645.4	645.5	623.7	623.8	601.1	601.1	577.2	577.3
	67	717.8	546.8	691.4	536.3	663.8	525.3	634.9	514.0	604.7	502.2
85	62	703.3	703.4	682.2	682.3	659.9	660.0	636.5	636.5	611.7	611.8
	67	720.3	659.1	694.8	647.9	668.4	635.9	641.1	622.9	613.1	608.0
	72	781.7	539.2	753.0	528.9	723.1	518.2	691.9	507.1	659.3	495.7

Chart PD-67. SCRF/SIRF 50 Fan Performance for CV or with VFD

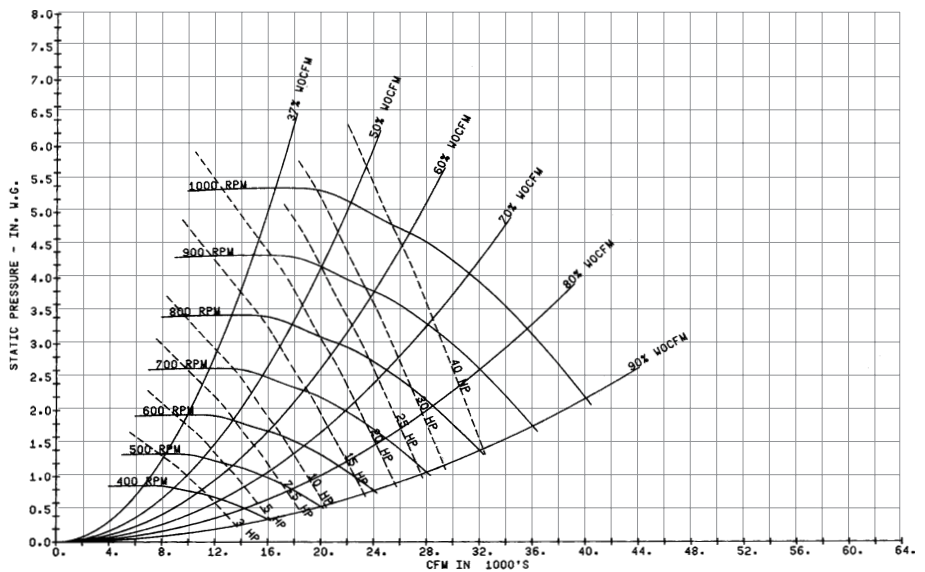
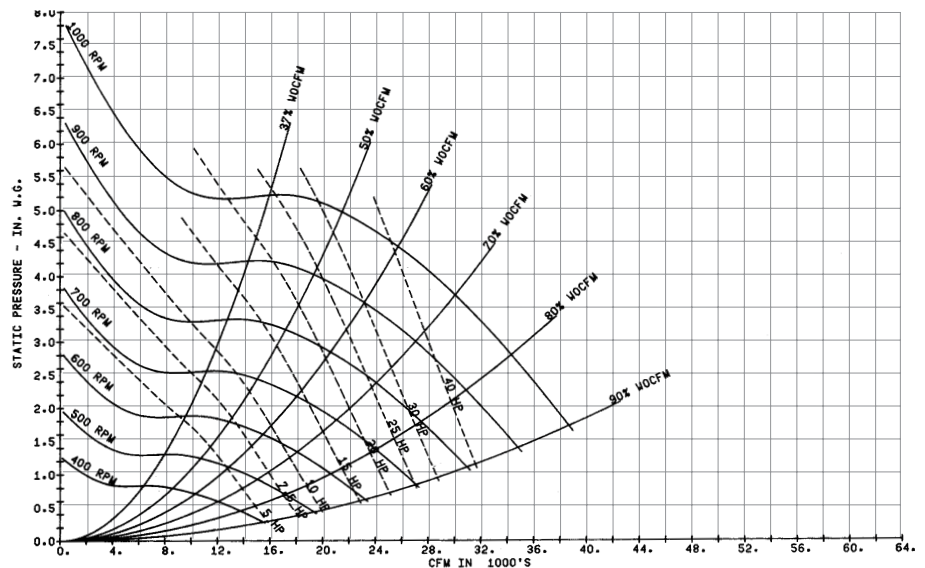

Chart PD-68. SCRF/SIRF 50 Fan Performance with Inlet Guide Vanes



Note:
 1. Fan curves include refrigerant coil and internal cabinet static losses. To determine static pressure to be used with these curves, add filter, economizer, flexible horizontal discharge and heat pressure drops to external duct static pressure.



Performance Data

Air-Cooled 60-Ton

Table PD-51. SCRF/SIRF 60 Gross Cooling Capacity - 29,800 cfm

		Entering Ambient Air Temperature									
		75 F		85 F		95 F		105 F		115 F	
EDB F	EWB F	Tot MBh	Sen MBh	Tot MBh	Sen MBh	Tot MBh	Sen MBh	Tot MBh	Sen MBh	Tot MBh	Sen MBh
70	62	874.8	591.1	840.5	576.2	804.8	560.8	767.6	544.9	728.7	528.5
	67	954.6	427.0	917.3	412.4	878.5	397.4	838.1	381.9	796.1	366.0
75	62	874.6	748.6	840.9	733.7	805.9	718.3	769.5	702.2	731.9	685.6
	67	953.8	583.7	916.5	569.1	877.8	553.9	837.4	538.3	795.4	522.2
80	72	1038.1	418.6	997.7	404.3	955.6	389.7	911.8	374.6	866.4	359.1
	62	889.2	889.3	860.2	860.3	829.8	829.9	797.8	797.9	764.2	764.3
85	67	953.0	739.9	915.8	725.1	877.0	709.8	836.7	694.1	795.3	678.0
	72	1037.3	574.2	996.9	559.8	954.8	545.0	911.1	529.8	865.7	514.1
85	62	939.6	939.6	909.5	909.6	877.8	877.9	844.6	844.7	809.7	809.8
	67	958.7	895.7	923.0	880.3	886.0	863.8	848.4	845.4	809.7	809.8
	72	1036.5	729.2	996.1	714.7	954.0	699.7	910.3	684.4	865.0	668.6

Chart PD-69. SCRF/SIRF 60 Fan Performance for CV or with VFD

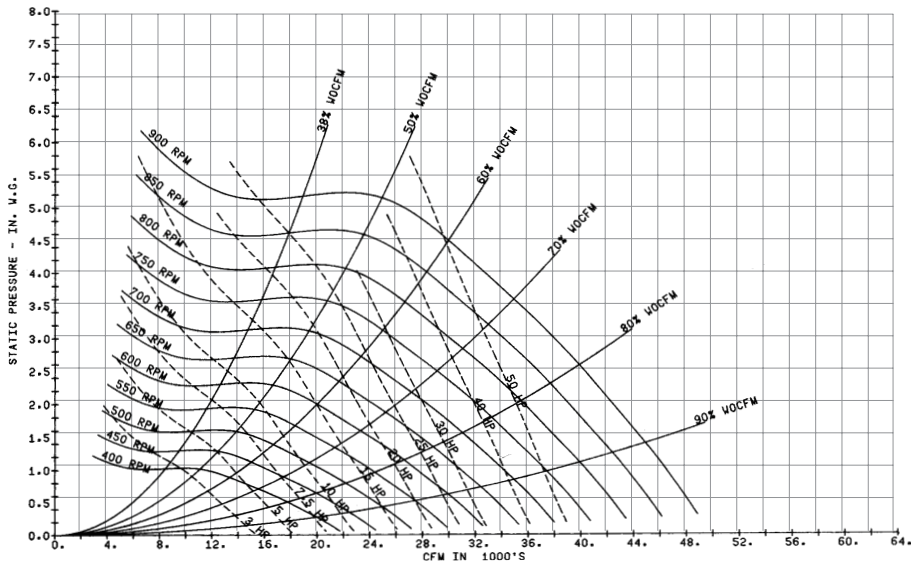
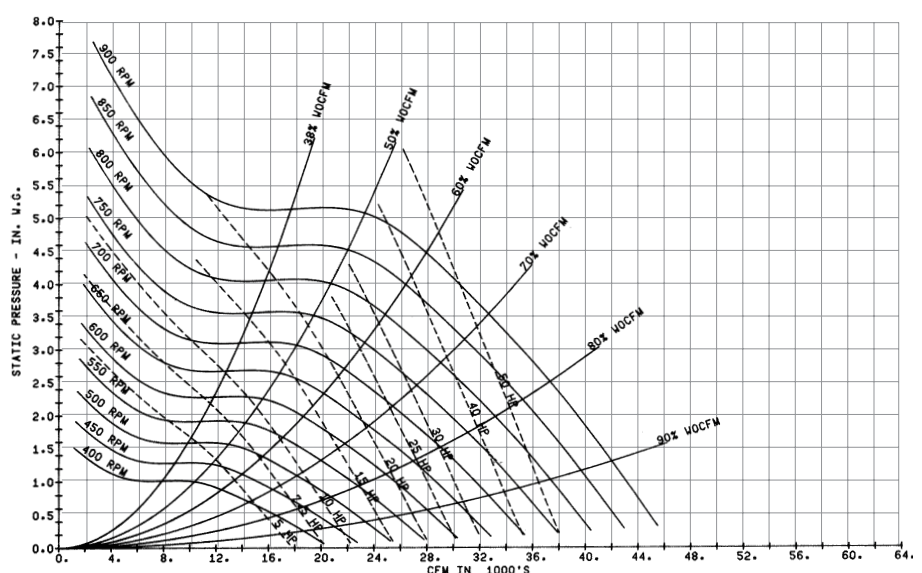

Chart PD-70. SCRF/SIRF 60 Fan Performance with Inlet Guide Vanes



Note:

1. Fan curves include refrigerant coil and internal cabinet static losses. To determine static pressure to be used with these curves, add filter, economizer, flexible horizontal discharge and heat pressure drops to external duct static pressure.



Performance Data

Self-Contained Heating Coils

Table PD-52. Hot Water Heating Capacity

Unit Size	Airflow cfm	Capacity MBh	180 F		200 F		
			LAT F	Flow gpm	LAT F	Flow gpm	
20 tons	8000	237.2	87.3	23.7	287.6	93.2	28.7
22 tons	8800	249.1	86.1	24.9	302.2	91.6	30.1
25 tons	10000	266.2	84.5	26.6	323.0	89.8	32.2
29 tons	11600	287.3	82.8	28.7	348.7	87.7	34.8
32 tons	12800	302.2	81.8	30.2	366.8	86.4	36.6
35 tons	14000	316.2	80.8	31.6	384.0	85.3	38.3
38 tons	15200	329.6	80.0	32.9	400.2	84.3	39.9
42 tons	16800	471.2	85.9	47.1	567.8	91.2	56.6
46 tons	18400	494.0	84.8	49.4	595.3	89.8	59.3
52 tons	20800	526.4	83.3	52.6	634.5	88.1	63.2
58 tons	23200	556.7	82.1	55.6	671.2	86.7	66.9
65 tons	26000	589.9	80.9	58.9	711.2	85.2	70.9
72 tons	28800	620.9	79.9	62.0	748.7	84.0	74.6
80 tons	29800	631.5	79.5	63.1	761.5	83.6	75.9

Based on 60 degree F EAT with a 20 degree F water temperature difference.

Table PD-53. Steam Heating Capacity

Unit Size	Airflow cfm	2 psi		5 psi		10 psi	
		Capacity MBh	LAT F	Capacity MBh	LAT F	Capacity MBh	LAT F
20 tons	8000	257.4	89.7	271.6	91.3	291.6	93.6
22 tons	8800	272.2	88.5	287.1	90.1	308.3	92.3
25 tons	10000	292.7	87.0	308.8	88.5	331.6	90.6
29 tons	11600	317.6	85.2	335.1	86.6	359.9	88.6
32 tons	12800	334.7	84.1	353.2	85.4	379.3	87.3
35 tons	14000	350.5	83.1	369.9	84.4	397.3	86.2
38 tons	15200	365.3	82.2	385.4	83.4	414.0	85.1
42 tons	16800	500.5	87.5	528.1	89.0	567.1	91.1
46 tons	18400	526.7	86.4	555.7	87.8	596.8	89.9
52 tons	20800	563.0	85.0	594.1	86.3	638.1	88.3
58 tons	23200	596.3	83.7	629.3	85.0	675.9	86.9
65 tons	26000	631.7	82.4	666.7	83.6	716.2	85.4
72 tons	28800	663.9	81.3	700.7	82.4	752.8	84.1
80 tons	29800	674.7	80.9	712.1	82.0	765.1	83.7

Based on 60 degree F EAT

Controls

INTELLIPAK®

Signature Series Self-Contained Units

We've redesigned the self-contained unit with the latest control technology to make it even better! New modular DDC controls with human interface (HI) panel make self-contained units more flexible and easier to operate.

Controls are Trane-designed to work with Trane equipment for optimum efficiency. The factory installs and commissions each control component to ensure simple and reliable operation.

Furthermore, the DDC control's modular design allows greater application flexibility using up to twelve different modules, dependent upon unit options. You can order exactly what the job requires as options, instead of one large control package. And since unit features are distributed among multiple printed circuit boards, field replacement is easy.

Depending upon unit options, IntelliPak® units can operate as:

- 1) stand-alone
- 2) interface with Trane's Tracer® building management system
- 3) interface with a generic (non-Trane) building management system.

Available Input and Output Points

RTM Module (on all units)

Binary inputs

- Emergency stop
- External auto/stop
- Unoccupied/occupied
- Dirty filter
- VAV changeover with hydronic heat
- Units with staged heat interface have 1-3 additional points

Binary outputs

- VAV box drive max (VAV units only)
- CV Unoccupied mode indicator (CV units only)
- Alarm
- Fan run request
- Water pump request (water-cooled only)
- Units with staged heat interface have 1-3 additional points

Analog input

- Airside economizer damper minimum position

Analog output

- Outside air damper actuator

Heat Module Option

- Analog output

Generic BAS Option (GBAS)

Binary inputs

- Demand limit contacts

Binary outputs

- Dirty filter relay
- Refrigeration fail relay
- Heat fail relay
- Supply fan fail relay
- Active diagnostics

Analog inputs

- Occupied zone cooling setpoint
- Occupied zone heating setpoint
- Unoccupied zone cooling setpoint
- Unoccupied zone heating setpoint or minimum outside air flow setpoint
- Supply air cooling setpoint
- Supply air heating setpoint

- Supply air static pressure setpoint

Comparative Enthalpy Module (ECEM)

Option

Analog inputs

- Return air temperature
- Return air humidity

Ventilation Override Module (VOM)

Option

Binary inputs

- VOM mode A, unit off
- VOM mode B, pressurize
- VOM mode C, exhaust
- VOM mode D, purge
- VOM mode E, purge w/duct pressure control

Binary output

- V.O. relay

Tracer® Interface (TCI) option

Binary input

- Enthalpy enable airside economizer

Binary outputs

- Compressor on/off status
- Ventilation status
- Condenser water flow status
- Heat status

Analog outputs

- Supply air pressure
- Supply air temperature
- Suction temperature of each circuit
- Entering economizer water temperature
- Zone temperature
- Entering condenser water temperature
- Supply air temperature reset signal
- Morning warmup sensor temperature
- Entering air temperature

Analog inputs

- Cooling and heating setpoints
- VAV discharge air temperature setpoints
- Supply air pressure setpoint
- Cooling and heating enable/disable
- Air economizer enable/disable
- Airside economizer minimum position
- Unit priority shutdown

Controls

Standard IntelliPak® Unit Control Features

All set-up parameters are preset from the factory, requiring less start-up time during installation.

The human interface panel is easy to read and requires less time for building maintenance personnel to learn to interact with the unit. It features a clear language display (in English, Spanish, or French) that shows all of the self-contained unit control parameters, such as system on/off; demand limiting type; night setback setpoints; and many other setpoints. All adjustments are done through the human interface key-pad. Also the human interface panel allows you to monitor diagnostic points such as; sensor failures; supply airflow loss; and inoperative refrigerant circuit. No special tools are required for servicing the unit. Diagnostics are held in memory, even during power loss. This allows the operator/servicer to diagnose the failure root cause.

IntelliPak® Unit Features

- Unit mounted human interface panel with a two line x 40 character language (English, Spanish, or French) display and a 16-function keypad that includes CUSTOM, DIAGNOSTICS, and SERVICE TEST MODE menu keys on IntelliPak® units
- Compressor lead/lag
- FROSTAT™ coil frost protection on all units
- Daytime warmup (occupied mode) on units with heating options and morning warmup operation on all units
- Supply air static overpressurization protection on units with inlet guide vanes and variable frequency drives (VFD's)
- Supply airflow proving
- Supply air tempering control with heating option
- Supply air heating control on VAV with hydronic heating option
- Mappable sensors and setpoint sources
- Occupied/unoccupied switching
- Timed override activation
- Programmable water purge during unoccupied mode



Human interface panel is available as unit or remote mounted.

Human Interface Panel (HI)

The human interface panel provides a 16-button keypad for monitoring, setting, editing and controlling. The HI panel is mounted in the unit's main control panel, accessible through the unit's control panel door.

The optional remote-mount version of the human interface (RHI) panel has all the functions of the unit-mounted version, except for the service mode. To use a RHI, the unit must be equipped with the remote HI interface option (model number digit 32 = 2), which includes an interprocessor communications bridge (IPCB). The RHI can be located up to 1,000 feet (304.8 m) from the unit. A single RHI can be used to monitor and control up to four self-contained units, each containing an IPCB.

The main menus of the human interface panels are:

- **STATUS** is used to monitor all temperatures, pressures, humidities, setpoints, input and output status.
- **CUSTOM** key allows the user to customize a status report - consisting of up to four screens of the data available in the main Status menu.
- **SETPPOINT** is used to edit all factory preset default setpoints.

- **DIAGNOSTICS** allows the user to review active and historical lists of diagnostic conditions. A total of 49 different diagnostics can be read at the human interface (HI) panel and the last 20 diagnostics can be held in an active history buffer log at the HI panel.
- **SETUP** allows the user to edit control parameters, sensor selections, setpoint source selections, output definitions, and numerous other points in this menu. All points have factory preset values to keep unnecessary editing to a minimum.
- **CONFIGURATION** allows changing of factory-preset unit configuration information. This information can be edited only if certain options are field-installed or deleted from the unit. For example, if a Trane communication interface (TCI) module or ventilation override module (VOM) were field-installed, the unit configuration will require editing to reflect those options for proper unit operation.
- **SERVICE** allows servicing or troubleshooting the unit by selecting component control outputs such as compressors, fans, damper position, etc. This menu is accessible only at the unit-mounted human interface panel.

Controls

Sequence of Operation

Control Sequences of Operation

Morning Warmup

This feature is available on all types of factory-installed heat units and on units with no heat. This function may still be selected to support systems with heat sources not provided by the self-contained unit. At the conclusion of unoccupied mode, the selected zone is heated to the user-defined morning warmup setpoint. The unit is then released to occupied mode. There are two types of morning warmup: full capacity or cycling capacity.

• Full Capacity Morning Warmup (MWU)

Full capacity morning warmup uses full heating capacity to heat the zone as quickly as possible. Full heating capacity is provided until the morning warmup setpoint is met. At this point, the unit is released to daytime mode.

• Cycling Capacity Morning Warmup (MWU)

Cycling capacity morning warmup provides gradual heating to overcome "building sink" as the zone is heated. Normal zone temperature control with varying capacity is used to raise the zone temperature to the MWU zone temperature setpoint. Cycling capacity MWU will operate until MWU setpoint is reached or for 60 minutes. Then the unit switches to occupied mode. Cooling will suspend until building load conditions exceed the MWU setpoint of 3 F (1.7 C), which is field adjustable.

Note: When using the morning warmup option in a heating/cooling self-contained unit in a VAV system, it is important to maintain airflow through the unit. This can be accomplished by electrically tying the VAV boxes to the VAV drive max output relay contacts on the unit's RTM module board or by using changeover thermostats. Either of these methods will assure adequate airflow through the unit and satisfactory heating.

Ventilation Override (VOM) Option

The user can customize up to five different override sequences for purposes of ventilation override control. If more than one VOM sequence is being requested, the sequence with the highest priority is initiated first. Priority schedule

is that sequence "A" (unit off) is first, with sequence "E" (purge with duct pressure control) last.

• UNIT OFF sequence "A"

When complete system shut down is required, the following sequence can be used.

- Supply fan – Off
- Supply fan VFD – Off (0 Hz) (if equipped)
- Inlet guide vanes – closed (if equipped)
- Outside air dampers – Closed
- Heat – all stages – Off, Modulating heat output at 0 vdc
- Occupied/Unoccupied output – Deenergized
- VO relay – Energized
- Exhaust fan (field-installed) - Off
- Exhaust damper (field-installed) - Closed

• PRESSURIZE sequence "B"

This override sequence can be used if a positively pressurized space is desired instead of a negatively pressurized space.

- Supply fan – On
- Supply fan VFD – On (60 Hz) (if equipped)
- Inlet guide vanes/VAV boxes – Open (if equipped)
- Outside air dampers – Open
- Heat – all stages – Off, Modulating heat output at 0 vdc
- Occupied/Unoccupied output - Energized
- VO relay - Energized
- Exhaust fan (field-installed) - Off
- Exhaust damper (field-installed) - Closed

• EXHAUST sequence "C"

With the building's exhaust fans running and the unit's supply fan off, the conditioned space becomes negatively pressurized. This is desirable for clearing the area of smoke when necessary; i.e. from an extinguished fire, to keep smoke out of areas that were not damaged.

- Supply fan – Off
- Supply fan VFD – Off (0 Hz) (if equipped)
- Inlet guide vanes – Closed (if equipped)
- Outside air dampers – Closed
- Heat – all stages – Off, Modulating heat output at 0 vdc
- Occupied/Unoccupied output – Deenergized
- VO relay – Energized

- Exhaust fan (field-installed) - On
- Exhaust damper (field-installed) - Open

• Purge sequence "D"

This sequence could be used for purging the air out of a building before coming out of unoccupied mode of operation on VAV units. Also, it can be used to purge smoke or stale air.

- Supply fan – On
- Supply fan VFD – On (60 Hz) (if equipped)
- Inlet guide vanes/VAV boxes – Open (if equipped)
- Outside air damper – Open
- Heat – all stages – Off, Modulating heat output at 0 vdc
- Occupied/Unoccupied output – Energized
- VO relay – Energized
- Exhaust fan (field-installed) - On
- Exhaust damper (field-installed) - Open

• Purge with duct pressure control "E"

This sequence can be used when supply air control is required for smoke control.

- Supply fan – On
- Supply fan VFD – On (if equipped)
- Inlet guide vanes – controlled by supply air pressure control function with supply air pressure high limit disabled
- Outside air dampers – Open
- Heat – all stages – Off, Modulating heat output at 0 vdc
- Occupied/Unoccupied output – Energized
- VO relay – Energized
- Exhaust fan (field-installed) - On
- Exhaust damper (field-installed) - Open

Note: Each system (cooling, exhaust, supply air, etc.) within the unit can be redefined in the field for each of the five sequences, if required. Also the definitions of any or all of the five sequences may be locked into the software by simple key strokes at the human interface panel.



Controls

Sequence of Operation

Generic Building Automation System Module (GBAS) Option

The generic building automation system module (GBAS) provides broad control capabilities for building automation systems other than Trane's Tracer[®] system. A field provided potentiometer or a 0-5 vdc signal can be applied to any of the inputs of the GBAS to provide the following inputs and outputs.

• GBAS Analog Inputs

Four analog inputs that can be configured to be any of the following:

- (1) Occupied zone cooling
- (2) Unoccupied zone cooling
- (3) Occupied zone heating
- (4) Unoccupied zone heating
- (5) SA cooling setpoint
- (6) SA heating setpoint
- (7) Space static pressure setpoint
- (8) SA static pressure setpoint

• GBAS Binary Outputs

Each of the five (5) relay outputs can be mapped to any/all of the available diagnostics.

• Demand Limiting Binary Input

This function is operational on units with a GBAS and is used to reduce electrical consumption at peak load times. There are two types of demand limiting, 50% and 100%. When demand limiting is needed, mechanical cooling and heating operation are either partially (50%), or completely disabled (100%) to save energy. The demand limit definition is user definable at the human interface panel. Demand limit binary input accepts a field supplied switch or contact closure. When the need for demand limiting has been discontinued, the unit's cooling/heating functions will again become fully enabled.

Evaporator Coil Frost Protection FROSTAT™

A temperature sensor on the evaporator is used to determine if the coil is getting close to a freezing condition. Mechanical cooling capacity is shed as necessary to prevent icing.

The FROSTAT™ system eliminates the need for hot gas bypass and adds a suction line surface temperature sensor mounted near the TXV bulb location to shut off the cooling when coil frosting conditions occur. The supply fan is not

shut off and will de-ice the coil. Timers prevent the compressors from rapid cycling.

Occupied/Unoccupied Switching

There are four ways to switch occupied/unoccupied:

- (1) Programmable night setback sensor
- (2) Field-supplied contact closure (hardwired binary input to RTM)
- (3) Tracer[®]
- (4) Factory-mounted time clock

• Field Supplied Occupied/Unoccupied input on the RTM

This input accepts a field supplied switch or contacts closure such as a time clock.

• Trane Tracer[®] System

The Trane Tracer[®] system can control the occupied/unoccupied status of the self-contained unit.

• Factory Mounted Time Clock

A time clock can control the occupied/unoccupied status of the self-contained unit.

Timed Override Activation - ICS

This function is operational whenever the unit's RTM module board is used as the zone temperature sensor source, which can be set at the human interface panel. When this function is initiated by the push of the override button on the zone sensor, the unit will switch to the occupied mode. Unit operation (occupied mode) during timed override is terminated by a signal from Tracer[®].

Timed Override Activation - Non-ICS

This function is active whenever the unit's RTM module board is selected as the zone temperature source, which can be set at the human interface panel. When this function is initiated by the push of the override button on the zone sensor, the unit will switch to the occupied mode. Automatic cancellation of the timed override mode occurs after three hours of operation.

Low Ambient Compressor Lockout

This function will lock out the compressor if the outdoor air temperature is below the low ambient compressor lock-out temperature setpoint when using a field-installed outside air sensor. This setpoint is adjustable at the human interface panel. Compressors will lock out when outdoor air temperature falls below that selected temperature and will start again

when the temperature rises 5 F above the setpoint.

Comparative Enthalpy Control of Airside Economizer Option

An optional comparative enthalpy system is used to control the operation of the economizer and measures the temperature and humidity of both return air and outside air to determine which source has lower enthalpy. This system allows true comparison of outdoor air and return air enthalpy by measurement of outdoor and return air temperatures and humidities.

Note: If comparative enthalpy is not ordered, the standard method compares outdoor air enthalpy with a fixed reference enthalpy, set through the human interface panel.

Compressor Lead/Lag

Compressor lead/lag is a user-selectable feature through the human interface panel available on all units. After each request for compressor operation, the lead refrigeration circuit or compressor switches, thereby causing a more equitable or balanced run time among compressors.

Emergency Stop Input

A binary input is provided on the unit's RTM module board for installation of a field-provided switch or contacts to immediately shutdown all unit functions.

Water Flow Control

With compatible piping configurations, the unit can be configured to provide:

- 1) Constant water flow with basic or intermediate piping or
- 2) Variable water flow with intermediate piping only.

Constant water flow is for condenser pumping systems that are not capable of unloading the water-pumping system. Variable water flow maximizes energy saving by unloading the water pumping system.

Head Pressure Control

• Water-Cooled Condensers

Units that are set up for variable water flow will modulate a water valve to maintain a user-defined condensing temperature setpoint. Condensing temperature will be referenced utilizing factory installed sensors located at each condenser.

Controls

Sequence of Operation

• Air-Cooled Condensers

Condenser fans will stage per a user-defined setting. If the condenser is equipped with head pressure control (air modulation on last stage of condenser capacity), the condenser airflow will modulate to maintain condensing temperature setpoint. Condensing temperature is determined by sensors located at each condenser coil.

Water Purge

This user-definable feature allows the user to select a purge schedule to automatically circulate water through the economizer and condensers periodically during non-operational times. This allows fresh chemicals to circulate in waterside heat exchangers.

Airside Options

Inlet Guide Vane Control

Inlet guide vanes are driven by a modulating 0-10 vdc signal from the RTM module. A pressure transducer measures duct static pressure, and the inlet guide vanes modulate to maintain the supply air static pressure within an adjustable user-defined range. The range is determined by the supply air pressure setpoint and supply air pressure deadband, which are set through the human interface panel.

Inlet guide vane assemblies installed on the supply fan inlet regulate fan capacity and limit horsepower at lower system air requirements. When in any position other than full open, the vanes pre-spin the air in the same direction as supply fan rotation. As the vanes approach the full-closed position, the amount of "spin" induced by the vanes increases at the same time that intake airflow and fan horsepower diminish. The inlet guide vanes will close when the supply fan is off.

Variable Frequency Drive (VFD) Control

Variable frequency drives are driven by a modulating 0-10 vdc signal from the RTM module. A pressure transducer measures duct static pressure, and the VFD adjusts the fan speed to maintain the supply air static pressure within an adjustable user-defined range. The range is determined by the supply air pressure setpoint and supply air pressure deadband, which are set through the human interface panel.

Variable frequency drives provide supply fan motor speed modulation. The drives will accelerate or decelerate as required to maintain the supply static pressure setpoint.

Bypass control is offered as an option to provide full nominal airflow in the event of drive failure. Manual bypass is initiated at the human interface panel. When in the bypass mode, VAV boxes will need to be fully opened. The self-contained unit will control heating and cooling functions to maintain setpoint from a user defined zone sensor. Supply air static pressure limit will be active in this mode.

Supply Air Static Pressure Limit

The opening of the inlet guide vanes and VAV boxes are coordinated during unit start up and transition to/from occupied/unoccupied modes to prevent overpressurization of the supply air ductwork. However, if for any reason the supply air pressure exceeds the user-defined supply air static pressure limit that was set at the human interface panel, the supply fan/VFD is shut down and the inlet guide vanes close. Then unit will attempt to restart, up to three times. If the overpressurization condition still occurs on the third restart, the unit shuts down and a manual reset diagnostic sets and displays at the human interface panel.



Sequence of Operation

Controls

Zone Temperature Control Unit Sequence Of Operation

1

Occupied Zone Temperature Control

Cooling/Waterside Economizer

During occupied cooling mode, the waterside economizer option and mechanical cooling function to control zone temperature. If the entering condenser water temperature is appropriate to use “free cooling,” the economizer initiates to attempt to satisfy the cooling zone temperature setpoint with the compressors staging on as necessary. Minimum on/off timing of compressors prevents rapid cycling.

Waterside economizing enables when the unit’s entering water temperature is below the unit’s entering mixed air temperature by 4 F plus the user adjustable economizer approach temperature. The approach temperature default is 4 F and is adjustable from 0-9 F at the human interface (HI) panel.

Waterside economizing disables when the unit’s entering water temperature is not below the unit’s entering mixed air temperature by at least the water economizer approach temperature. The approach temperature defaults to 4 F and is adjustable from 0-9 F at the HI. The economizer acts as the first stage of cooling. If the economizer is unable to maintain the zone temperature setpoint, the compressor module will bring on compressors as required to meet the setpoint.

If the unit does not include an economizer, only mechanical cooling will operate to satisfy cooling requirements.

Cooling/Airside Economizer

During occupied cooling mode, the economizer option and mechanical cooling operate to control zone temperature. If the outside air enthalpy is appropriate for airside economizing or “free cooling,” the economizer initiates to satisfy the cooling zone temperature setpoint with the compressors staging on as necessary. Minimum on/off timing of compressors will prevent rapid cycling.

On units with an airside economizer, a call for cooling will modulate the fresh air

dampers open. The rate of economizer modulation is based on deviation of the zone temperature from setpoint; i.e., the further away from setpoint, the faster the fresh air damper will open. First stage of cooling will start after the economizer reaches full open.

Note that the airside economizer will only function freely if ambient conditions are below the enthalpy control settings or below the return air enthalpy if unit has comparative enthalpy installed. If outside air is not suitable for “economizing,” the fresh air dampers drive to the minimum open position. A field adjustable, factory default setting in the human interface panel or Tracer® can provide the input to establish the minimum damper position.

At outdoor air conditions above the enthalpy control setting, only mechanical cooling is used and the fresh air dampers remain at minimum position.

If the unit does not include an airside economizer, only mechanical cooling will operate to satisfy cooling requirements.

Heating: Electric

On units with electric heating, the zone temperature can be controlled to a heating setpoint during the occupied mode by cycling a single stage electric heater. Interface is provided for field supplied single stage electric heat. The zone temperature heating setpoint and deadband are user defined at the human interface panel.

Heating: Hot Water or Steam

On units with hot water or steam heating, the zone temperature can be controlled to a heating setpoint during the occupied mode. The zone temperature heating setpoint and deadband are user defined at the human interface panel.

Supply Air Tempering

For hot water, steam, or electric heat units in the heat mode but not actively heating, if the supply air temperature drops to 10 F (5.5 C) below the occupied zone heating temperature setpoint, one stage of heat will be brought on to maintain a minimum supply air temperature. The unit transitions out of heat mode if the supply air temperature rises to 10 F above the occupied zone heating temperature setpoint.

Auto Changeover

When the system mode is auto, the mode will change to cooling or heating as necessary to satisfy the zone cooling and heating setpoints. The zone cooling and heating setpoints can be as close as 2 F (1.1 C) apart.

2

Unoccupied Zone Temperature Control

Cooling and Heating

Both cooling and heating modes can be selected to maintain unoccupied zone temperature deadbands. For unoccupied periods, heating, economizer operation, or compressor operation can be selectively locked out at the human interface panel.

Controls

Sequence of Operation

Supply Air Temperature Control Unit Sequence Of Operation

1

Occupied Supply Air Temperature Control

Cooling/Waterside Economizer

During occupied cooling mode, the waterside economizer option and mechanical cooling are used to control the supply air temperature. The supply air temperature setpoint and deadband are user defined at the human interface panel. Waterside economizing enables when the units entering water temperature is below the units entering mixed air temperature by 4 F plus the user adjustable economizer approach temperature. The approach temperature default is 4 F and is adjustable from 0-9 F at the HI. Waterside economizing disables when the units entering water temperature is not below the units entering mixed air temperature by at least the water economizer approach temperature.

The economizer acts as the first stage of cooling. If the economizer is unable to maintain the supply air setpoint, the compressor-module will bring on compressors as required to meet the setpoint. If the unit does not include an economizer, only mechanical cooling will satisfy cooling requirements.

Cooling/Airside Economizer

During occupied cooling mode of operation, the airside economizer option and mechanical cooling are used to control the supply air temperature. The supply air temperature setpoint and deadband are user-defined at the human interface panel. If the temperature of the mixed air is appropriate to use "free cooling," the economizer initiates to satisfy the supply air setpoint. Then if required, the mechanical cooling stages on to maintain supply air temperature setpoint. Minimum on/off timing of the mechanical cooling prevents rapid cycling.

On units with an airside economizer, a call for cooling will modulate the fresh air dampers open. The rate of economizer

modulation is based on deviation of the discharge temperature from setpoint, i.e., the further away from setpoint, the faster the fresh air damper will open. First stage of cooling initiates after the economizer reaches full open.

Note that the airside economizer is only allowed to function freely if ambient conditions are below the setpoint control settings or below the return air enthalpy, if unit has the comparative enthalpy option. If outside air is not suitable for "economizing," the fresh air dampers drive to the minimum open position. A field adjustable, factory default setting in the human interface panel or Tracer® can provide the input to establish the minimum damper position.

At outdoor air conditions above the setpoint or comparative enthalpy control setting, only mechanical cooling is used and the fresh air dampers remain at minimum position.

If the unit does not include an economizer, only mechanical cooling operates to satisfy cooling requirements.

Heating: Hot Water or Steam

On units with hot water or steam heating, the supply air temperature can be controlled to a heating setpoint during the occupied mode. The supply air temperature heating setpoint and deadband are user defined at the human interface panel. VAV occupied heating on hot water and steam heat units is initiated by closing a field-supplied switch or contacts connected to a changeover input on the unit's RTM module board.

Supply Air Setpoint Reset

Supply air reset can be used to adjust the supply air temperature setpoint on the basis of a zone temperature or outdoor air temperature. Supply air reset adjustment is available from the human interface panel for supply air heating and supply air cooling control.

Reset based on outdoor air temperature

Outdoor air cooling reset is sometimes used in applications where the outdoor temperature has a large effect on building load. When the outside air temperature is low and the building cooling load is low, the supply air setpoint can be raised, thereby preventing subcooling of critical zones. This reset can

lower usage of mechanical cooling, thus savings in compressor kW, but an increase in supply fan kW may occur.

Outdoor air heating reset is the inverse of cooling, with the same principles applied.

For both outdoor air cooling reset and heating reset, there are three user defined parameters that are adjustable through the human interface panel.

- Beginning reset temperature
- Ending reset temperature
- Maximum amount of temperature reset

Reset based on zone temperature

Zone reset is applied to the zone(s) in a building that tends to overcool or overheat. The supply air temperature setpoint is adjusted based on the temperature of the critical zone(s). This can have the effect of improving comfort and/or lowering energy usage. The user-defined parameters are the same as for outdoor air reset.

Supply Air Tempering (Hot Water and Steam Units Only)

When supply air temperature falls below the supply air temperature deadband low end, the heating valve modulates open to maintain the minimum supply air temperature setpoint.

2

Unoccupied Supply Air Temperature Control Zone Heating and Cooling

During unoccupied mode, the unit operates to maintain zone temperature with fan cycling as needed for building load. VAV boxes drive full open. However, unit airflow modulation control operates to maintain duct static setpoint. The unit controls zone temperature within the unoccupied zone cooling and heating (heating units only) deadbands.

Daytime Warmup

During occupied mode, if the zone temperature falls to a preset, user-defined zone low limit temperature setpoint, the unit is put into daytime warmup. The system changes over to CV heating, the VAV boxes drive full open. However, unit airflow modulation control operates to maintain duct static setpoint, and full heating capacity is provided until the daytime warmup setpoint is reached. The unit is then returned to normal occupied mode.

Controls

Zone Sensor Options

Standard On All Units



*Standard with all units
Zone temperature sensor, Accessory
Model Number Digit 6 = A, BAYSENS017*

This wall-mounted zone sensor ships with every Signature Series unit, CV or VAV. Additional sensors are also available for order using the accessory model number. It includes an internal thermistor and should be mounted in the zone. This sensor is available for use with all zone sensor options to provide remote sensing capabilities.

VAV



*Single setpoint sensor with system
function lights, Accessory Model Number
Digit 6 = H, BAYSENS021*

This wall-mounted zone sensor option is for use in VAV applications. Features and system control functions are:

- Temperature sensing in the zone
- System control switch with mode setting for Auto or Off
- Supply air single temperature setpoint
- Function status indicator lights:
 - SYS ON** glows continuously during normal operation, or blinks if system is in test mode.
 - COOL** glows continuously during cooling cycles or blinks to indicate a cooling system failure.
 - HEAT** glows continuously during heating cycles or blinks to indicate a heating system failure.
 - SERVICE** blinks or glows to indicate a problem. These signals vary depending on the particular equipment used.

VAV



*Programmable night-setback sensor,
Accessory Model Number Digit 6 = J,
BAYSENS020*

This programmable night setback sensor is for use in VAV applications. The sensor has a time clock function that provides communication to the self-contained unit through a 2-wire communications link. The desired transition times are programmed at the night setback sensor and communicated to the self-contained unit.

The programmable night setback (unoccupied mode) operates through the time clock provided in the sensors with night setback. When the time clock switches to night setback operation, the outdoor air dampers close and heating/cooling enables or disables, depending on set-up parameters. As the building load changes, the night setback sensor energizes the self-contained unit's heating/cooling (if enabled) function and the evaporator fan. The self-contained unit will cycle through the evening as heating/cooling (if enabled) is required in the space. When the time clock switches from night setback to occupied mode, all heating/cooling functions begin normal operation.

When using the night setback options with VAV heating/cooling, maintain airflow through the self-contained unit by electrically tying the VAV boxes to the unoccupied output relay contacts on the unit's RTM module board or by using changeover thermostats. Either of these methods will assure adequate airflow through the unit and satisfactory temperature control of the building.

Zone Sensor Options

Controls

CV



Dual setpoint, manual/automatic changeover sensor, Accessory Model Number Digit 6 = E, BAYSENS008

This zone sensor module is for use with cooling/heating CV applications. It provides the following features and system control functions:

- System control switch (Heat/Auto/Off/Cool): Allows you to select heating mode, cooling mode, automatic selection of heating or cooling as required, or turn the system off.
- Fan control switch (Auto/On): Allows you to select automatic fan operation while actively heating or cooling or continuous fan operation.
- Dual temperature setpoint levers allow you to set different cooling (blue lever) and heating setpoints (red lever).
- Thermometer to indicate temperature in the zone.

CV



Dual setpoint, manual/automatic changeover sensor with system function lights, Accessory Model Number Digit 6 = F, BAYSENS010

This zone sensor is for use with cooling/heating CV applications. It provides the following features and system control functions:

- System control switch to select heating mode (HEAT), cooling mode (COOL), AUTO for automatic selection of heating or cooling as required, or OFF to turn the system off.
- Fan control switch to select automatic fan operation while actively heating or cooling (AUTO), or continuous fan operation (ON).
- Dual temperature setpoint levers for setting cooling (blue lever) or heating (red lever).
- Thermometer to indicate temperature in the zone.
- Function status indicator lights:
SYS ON glows continuously during normal operation, or blinks if system is in test mode.

COOL glows continuously during cooling cycles or blinks to indicate a cooling system failure.

HEAT glows continuously during heating cycles or blinks to indicate a heating system failure.

SERVICE blinks or glows to indicate a problem. These signals vary depending on the particular equipment used.

CV



Programmable night setback sensor, Accessory Model Number Digit 6 = G, BAYSENS019

The programmable night setback sensor is for use in CV applications. The sensor has a time clock function that provides communication to the self-contained unit through a 2-wire communications link. The desired transition times are programmed at the night setback sensor and communicated to the self-contained unit.

The programmable night setback (unoccupied mode) operates through the time clock provided in the sensors with night setback. When the time clock switches to night setback operation, the outdoor air dampers close and heating/cooling enables or disables, depending on set-up parameters. As the building load changes, the night setback sensor energizes the self-contained unit's heating/cooling (if enabled) function and the evaporator fan. The self-contained unit will cycle through the evening as heating/cooling (if enabled) is required in the space. When the time clock switches from night setback to occupied mode, all heating/cooling functions begin normal operation.

Controls

Zone Sensor Options

Integrated Comfort™ Systems Sensors for CV and VAV Applications



Zone temperature sensor w/timed override buttons and local setpoint adjustment, Accessory Model Number Digit 6 = C, BAYSENS014C

This zone sensor is for use with cooling/heating ICS™. It provides the following features and system control functions:

- Remote temperature sensing in the zone
- A timed override button to move an Integrated Comfort™ System or a building management system from unoccupied to occupied mode.
- Setpoint thumbwheel for local setpoint adjustment
- Cancel button to cancel the unoccupied override command.



Zone temperature sensor w/timed override buttons, Accessory Model Number Digit 6 = B, BAYSENS013C

This zone sensor is for use with cooling/heating Integrated Comfort™ Systems (ICS). It provides the following features and system control functions:

- Remote temperature sensing in the zone
- A timed override button to move an ICS or building management system from it unoccupied to occupied mode.
- Cancel button to cancel the unoccupied override command.

Electrical Data

Selection Procedures

RLA = Rated Load Amps

Compressor LRA = Locked Rotor Amps

Fan Motor LRA = Locked Rotor Amps,
N.E.C. Table 430 - 150

FLA = Full Load Amps, N.E.C.
Table 430 - 150

Voltage utilization range is ± 10 percent

Determination of minimum circuit
ampacity (MCA).

MCA = 1.25 x largest motor amps/VFD
amps (FLA or RLA) + the sum of the
remaining motor amps.

Determination of maximum fuse size (MFS) and maximum circuit breaker size (MCB)

MFS and MCB = 2.25 x largest motor
amps (FLA or RLA) + the sum of the
remaining motor amps.

Units with the dual power option require
separate MFS and MCB calculations for
each electrical circuit:

1) fans and 2) compressors.

If the rating value calculation does not
equal a standard over current protective
device rating, use the next lower standard
rating as the maximum.

Table ED-1. Number of Compressors per Unit

	20	25 - 29	30 - 35	40	50	60
SCRF/SIRF	20	25 - 29	30 - 35	40	50	60
SCWF/SIWF	20 - 25	29 - 32	35 - 38	42 - 46	52 - 58	65 - 72
	10	2	1	3	2	-
	15	-	1	-	1	3
						3
						4

Table ED-2. SCWF/SIWF Compressor Electrical Data

HP	200V		460V		575V	
	RLA	LRA	RLA	LRA	RLA	LRA
10	33	269	14.5	117	11.5	94
15	46	409	20.5	178	16.5	143

Table ED-3. SCRF/SIRF Compressor Electrical Data

HP	200V		460V		575V	
	RLA	LRA	RLA	LRA	RLA	LRA
10	36.8	269	16.3	117	13.2	94
15	61.1	409	26	178	21.5	143

Table ED-4. Fan Without VFD Electrical Data

HP	200V		460V		575V	
	FLA	LRA	FLA	LRA	FLA	LRA
5	16.1	105	6.7	46	5.4	37
7.5	25.0	152	10.8	66	8.2	54
10	32.9	193	14.2	84	11.4	66
15	44.8	290	20.3	126	16.2	102
20	61.0	373	25.0	162	20.0	132
25	74.0	469	31.0	204	24.2	162
30	87.0	552	36.0	240	28.6	192
40	113.0	718	47.8	312	38.0	246
50	NA	NA	62.0	390	49.2	312

Table ED-5. Fan with VFD Electrical Data

HP	200V		460V	
	FLA	LRA	FLA	LRA
7.5	29.0	152	14.3	66
10	38.3	193	18.1	84
15	42.7	290	25.8	126
20	55.2	373	32.4	162
25	67.8	469	38.9	204
30	82.0	552	39.0	240
40	108.6	718	51.0	312
50	NA	NA	61.5	390

Note: Values are at the maximum VFD input rating and not the reduced motor values.



Electrical Data SCWF/SCRF

Table ED-6. Single Stage Electric Heat Electrical Data

SXWF Size	SXRF Size	Heat Kw	200V Amps	460V Amps
20	-	18	50	21.7
22	-	18	50	21.7
25	20	18	50	21.7
29	25	23	63.8	27.7
32	29	23	63.8	27.7
35	30	27	75	32.5
38	35	27	75	32.5
42	-	31.5	87.4	37.9
46	40	31.5	87.4	37.9
52	-	39	108.3	46.9
58	50	39	108.3	46.9
65	-	48	133.2	57.7
72	-	48	133.2	57.7
80	60	48	133.2	57.7

Note:
Electric heat amperage should not be considered when determining minimum circuit ampacity. The current of the unit in the heating mode will not exceed the current of the unit in the cooling mode.

Table ED-7. CCRC/CIRC Condenser Electrical Data

Unit Size Tons	Rated Voltage	# Fans	FLA (ea.)	LRA (ea.)	MCA	MFS. MCB
20, 29	200	4	4.1	20.7	17.43	20
	460	4	1.8	9	7.65	15
	575	4	1.4	7.2	5.95	15
35, 40	200	6	4.1	20.7	25.63	30
	460	6	1.8	9	11.25	15
	575	6	1.4	7.2	8.75	15
50, 60	200	8	4.1	20.7	33.83	40
	460	8	1.8	9	14.85	20
	575	8	1.4	7.2	11.55	15

Note:
All motors for CCRC/CIRC units are rated at 1 hp (.7457 kW).

Dimensions and Weights

Self-Contained 20-38 Tons

20-38 Ton Self-Contained

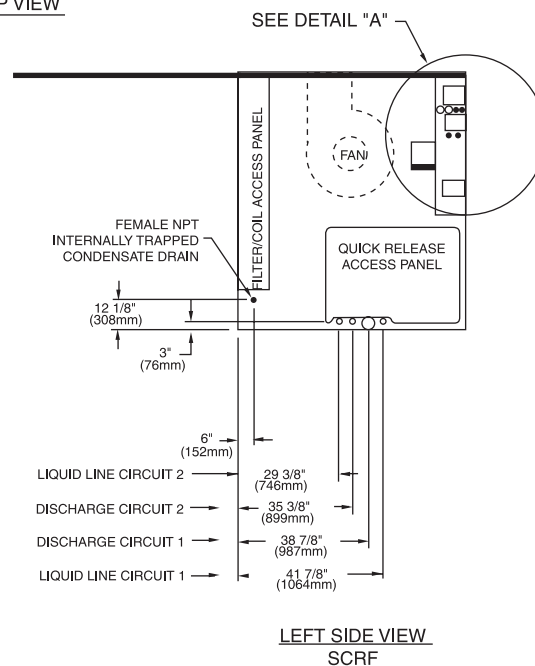
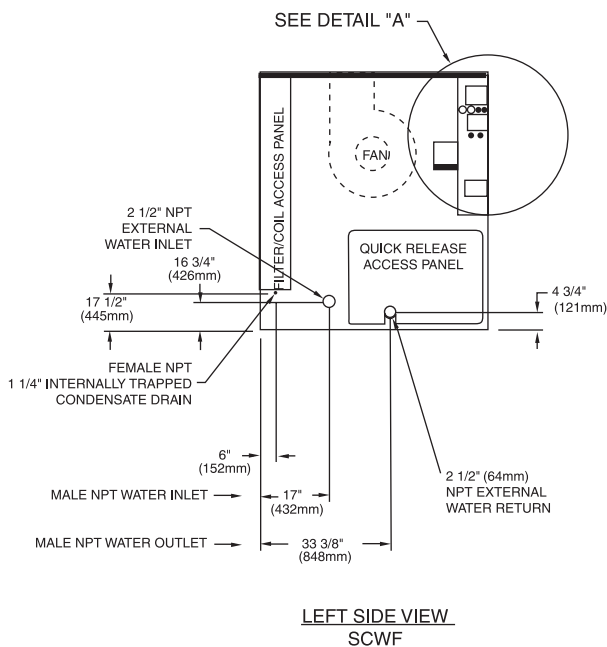
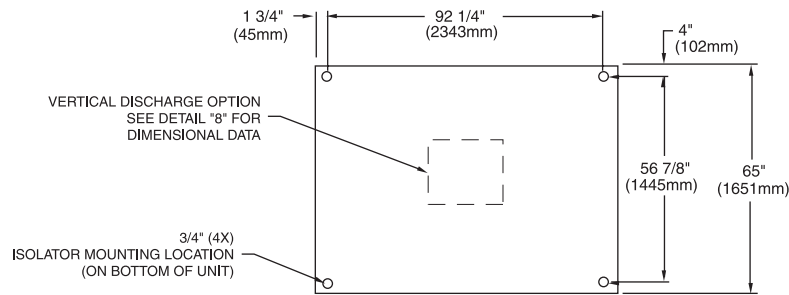
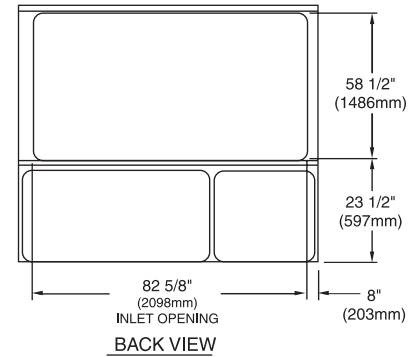
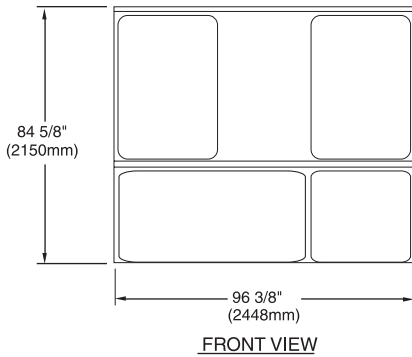

Dimensions and Weights

Self-Contained 40-80 Ton

40-80 Ton Self-Contained

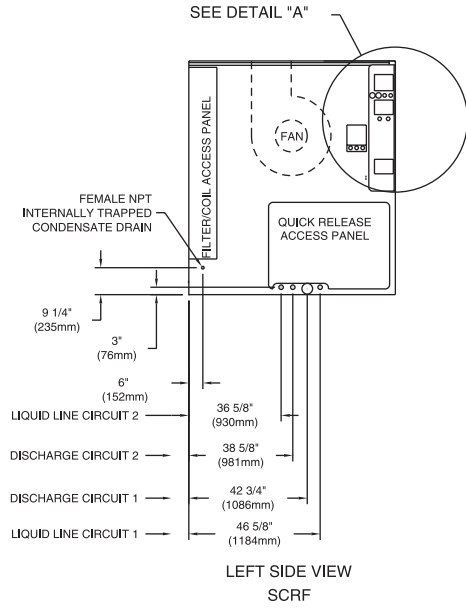
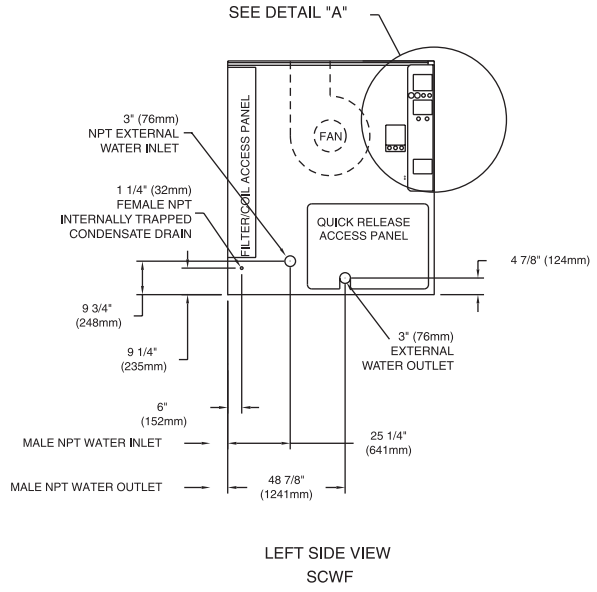
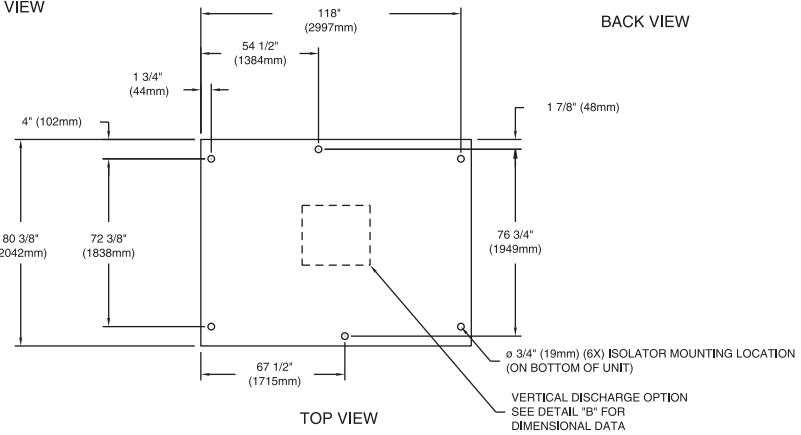
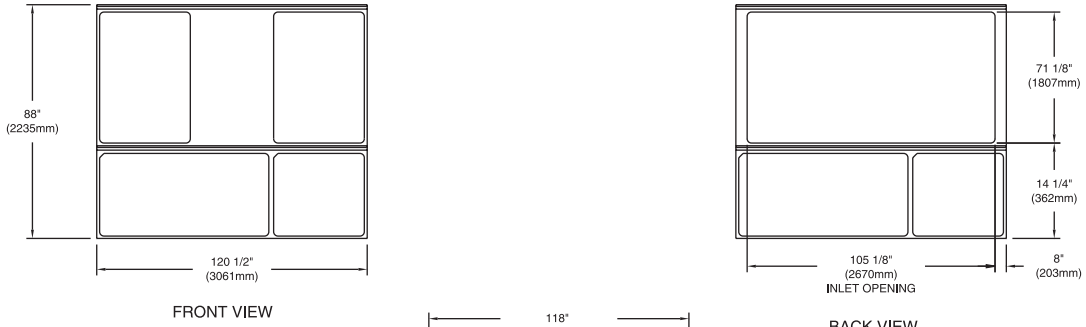

Dimensions and Weights

Self-Contained 20-80 Tons

Detail A Electrical Connections

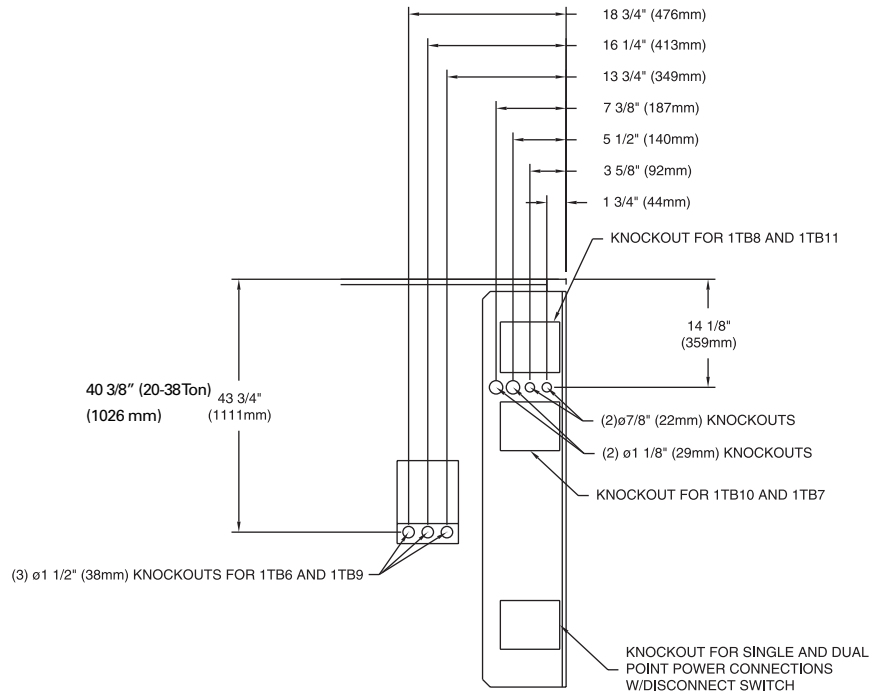

Detail B Discharge Dimensions

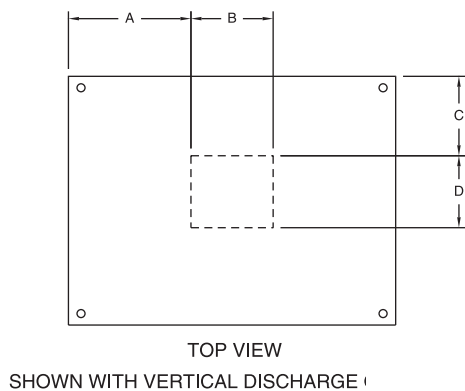

Discharge Dimensions - English - (inches)

Unit Tons	A	B	C	D
SXWF 20-25 SXRF 20	30 3/8	26 1/8	21 1/4	25 3/4
SXWF 29-32 SXRF 25-29	31 7/8	23 1/2	23 1/8	20 3/8
SXWF 35-38 SXRF 30-35	30 1/2	26 1/8	21 1/4	25 3/4
SXWF 42-80 SXRF 40-60	43 1/8	33 1/2	28 7/8	34 1/2

Discharge Dimensions - Metric - (mm)

Unit Tons	A	B	C	D
SXWF 20-25 SXRF 20	772	664	540	654
SXWF 29-32 SXRF 25-29	810	597	587	518
SXWF 35-38 SXRF 30-35	775	664	540	654
SXWF 42-80 SXRF 40-60	1095	851	733	876



Dimensions and Weights

Air-Cooled Condenser

CCRC Unit Dimensions

Unit Dimensions - English - (inches)

Unit Tons	AA	AB	AC
CCRC/CIRC 20, 29	70 1/8	7' - 4"	7' - 4"
CCRC/CIRC 35, 40	70 1/8	10' - 10 3/4"	7' - 4"
CCRC/CIRC 50, 60	70 1/8	14' - 8"	7' - 4"

Unit Dimensions - Metric (mm)

Unit Tons	AA	AB	AC
CCRC/CIRC 20, 29	1781	2235	2235
CCRC/CIRC 35, 40	1781	3321	2235
CCRC/CIRC 50, 60	1781	4470	2235

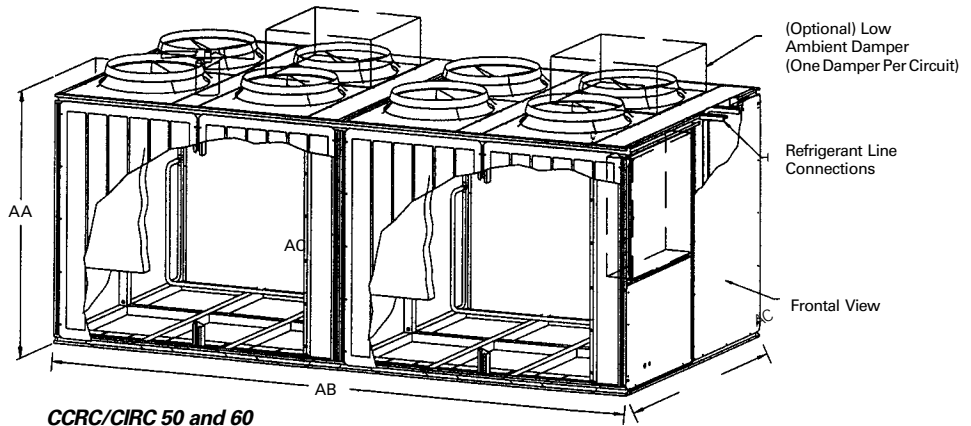
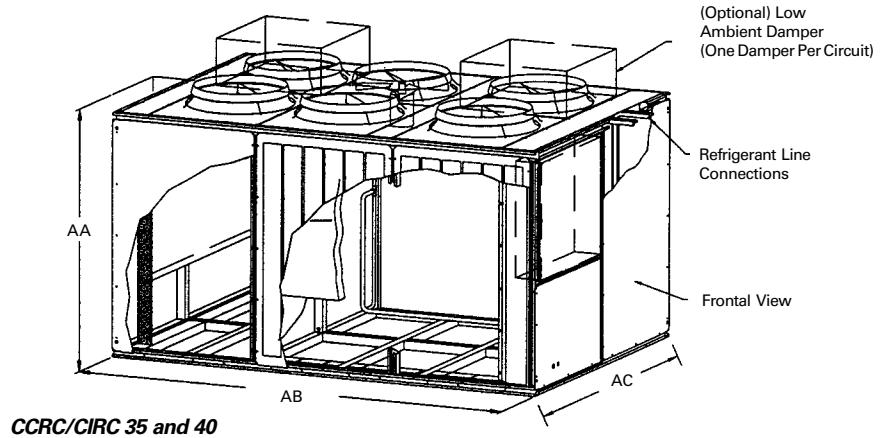
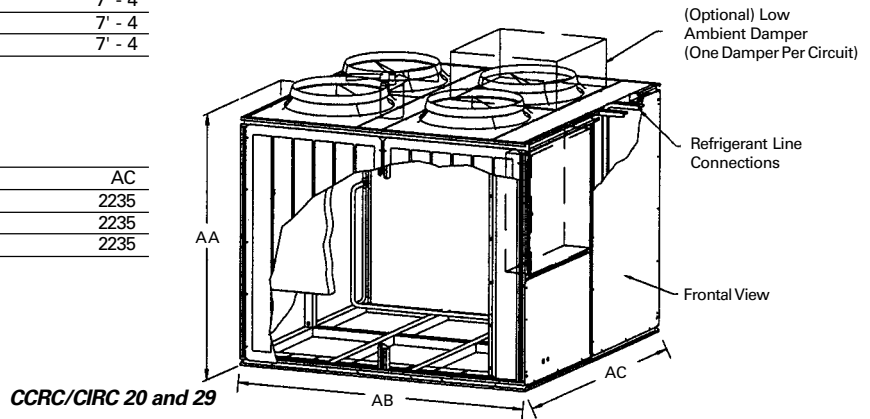

Dimensions and Weights

Air-Cooled Condenser

Refrigerant and Electrical Connections

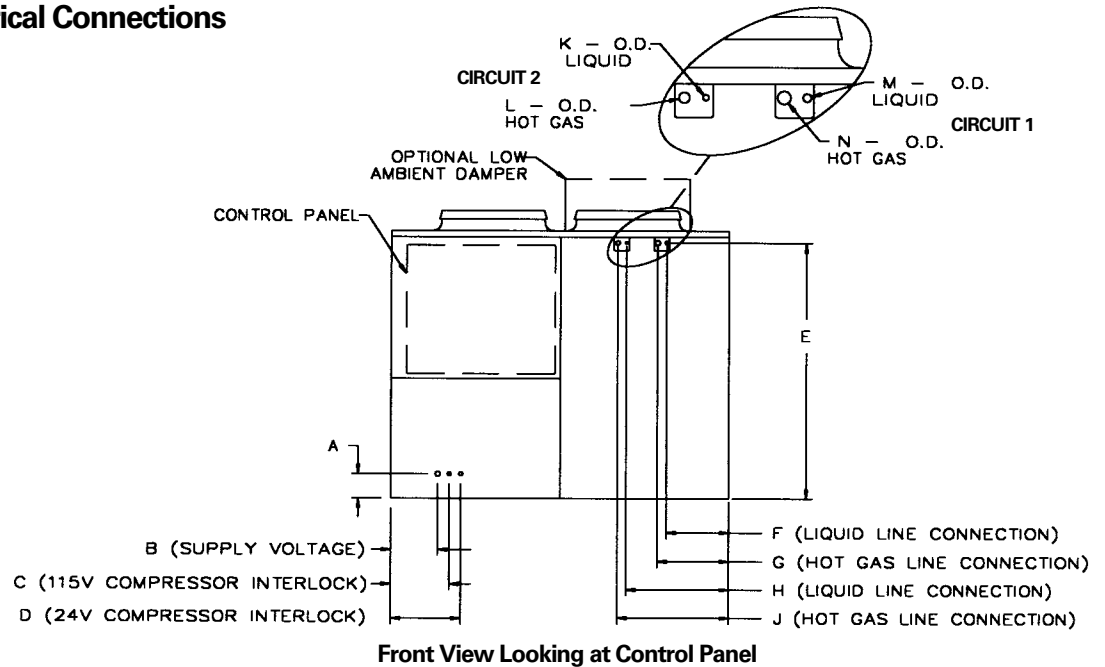

Electrical Connections - English - (inches)

Unit	A	B	C	D
CCRC/CIRC 20-32	6 ³ / ₈	12 ¹ / ₄	15 ¹ / ₄	18 ¹ / ₄
CCRC/CIRC 35-40	6 ³ / ₈	12 ¹ / ₄	15 ¹ / ₄	18 ¹ / ₄
CCRC/CIRC 50-60	6 ³ / ₈	12 ¹ / ₄	15 ¹ / ₄	18 ¹ / ₄

Electrical Connections - Metric - (mm)

Unit	A	B	C	D
CCRC/CIRC 20-32	162	311	387	464
CCRC/CIRC 35-40	162	311	387	464
CCRC/CIRC 50-60	162	311	387	464

Refrigerant Connections - English - (inches)

Unit	E	F	G	H	J	K	L	M	N
CCRC/CIRC 20-32	66 ⁷ / ₈	14 ³ / ₈	18 ¹ / ₂	24 ³ / ₄	29	⁵ / ₈	1 ¹ / ₈	⁵ / ₈	1 ¹ / ₈
CCRC/CIRC 35-40	66 ⁷ / ₈	14 ³ / ₈	18 ¹ / ₂	24 ³ / ₄	29	⁵ / ₈	1 ¹ / ₈	⁷ / ₈	1 ³ / ₈
CCRC/CIRC 50	66 ⁷ / ₈	14 ³ / ₈	18 ¹ / ₂	24 ³ / ₄	29	⁵ / ₈	1 ¹ / ₈	⁷ / ₈	1 ⁵ / ₈
CCRC/CIRC 60	66 ⁷ / ₈	14 ³ / ₈	18 ¹ / ₂	24 ³ / ₄	29	⁷ / ₈	1 ⁵ / ₈	⁷ / ₈	1 ⁵ / ₈

Refrigerant Connections - Metric - (mm)

Unit	E	F	G	H	J	K	L	M	N
CCRC/CIRC 20-32	1699	365	470	629	737	16	29	16	29
CCRC/CIRC 35-40	1699	365	470	629	737	16	29	22	35
CCRC/CIRC 50	1699	365	470	629	737	16	29	22	41
CCRC/CIRC 60	1699	365	470	629	737	22	41	22	41



Dimensions and Weights

Self-Contained Heating Coils

Hot Water Coil

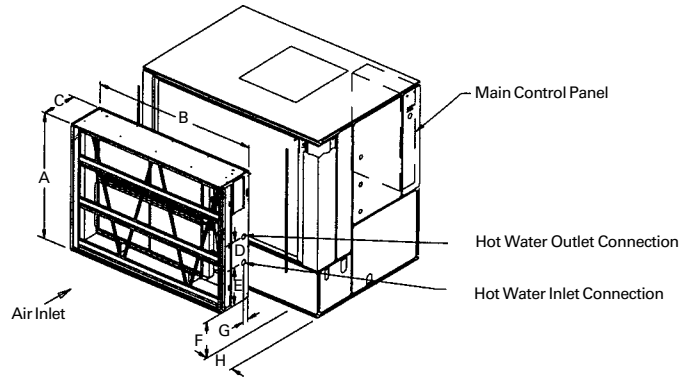

- Notes:
1. All coils are factory mounted, piped, and wired.
 2. All piping connections are 1-1/2" (38.1mm) female NPT fittings.

Hot Water Coil Piping Locations - English (inches)

	A	B	C	D	E	F	G	H
Unit Sizes 20 - 38	60 3/8	82 7/8	18	20 5/8	8 1/8	22 3/8	3 5/8	8 1/4
Unit Sizes 42 - 80	72 7/8	105 1/4	18	24 1/2	10 3/4	13 1/4	3 5/8	8 1/4

Hot Water Coil Piping Locations - Metric (mm)

	A	B	C	D	E	F	G	H
Unit Sizes 20 - 38	1534	2105	457	524	206	568	92	210
Unit Sizes 42 - 80	1851	2680	457	404.9	273	337	92	210

Steam Coil

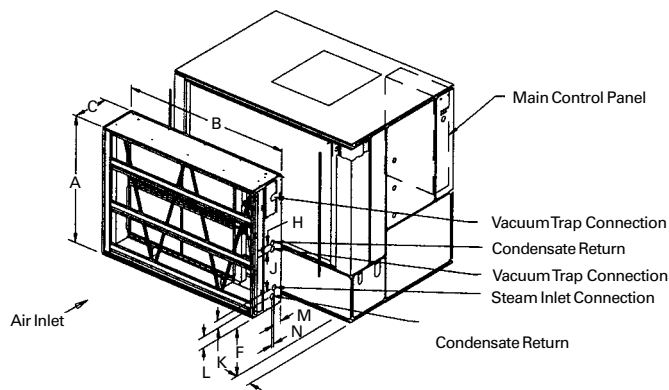

- Notes:
1. All coils are factory mounted, piped, and wired.
 2. All piping connections are 1-1/2" (38.1mm) female NPT fittings.

Piping Locations For Steam Coils - English (inches)

	A	B	C	D	E	F	G	H	J	K	L	M	N
Unit Sizes 20 - 38	60 3/8	82 7/8	18	-	-	22 3/8	-	3	18 1/2	3 7/8	5	4 3/8	1 1/4
Unit Sizes 42 - 80	72 7/8	105 1/4	18	-	-	13 1/4	-	3	22 1/8	6 3/8	5 3/8	4 3/8	1 1/4

Piping Locations For Steam Coils - Metric (mm)

	A	B	C	D	E	F	G	H	J	K	L	M	N
Unit Sizes 20 - 38	1534	2105	457	-	-	568	-	76	470	98	127	111	32
Unit Sizes 42 - 80	1851	2680	457	-	-	337	-	76	562	162	137	111	32

Dimensions and Weights

Flexible Horizontal Discharge Plenum

Flexible Horizontal Discharge Plenum

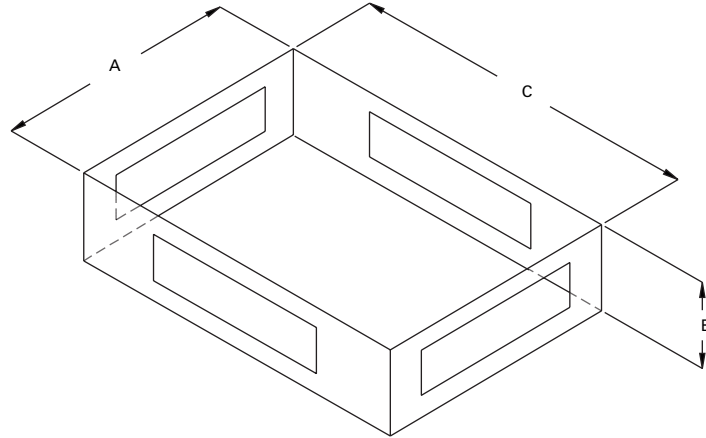

Plenum Dimensions - English - (inches)

		A	B	C	Weight
Unit Sizes 20-38	Low	64 ⁷ / ₈	24 ⁵ / ₈	95 ⁷ / ₈	325 lbs.
	Std.	64 ⁷ / ₈	32 ³ / ₈	95 ⁷ / ₈	430 lbs.
	Ext.	64 ⁷ / ₈	45	95 ⁷ / ₈	705 lbs.
Unit Sizes 42-80	Low	80 ³ / ₈	21 ¹ / ₈	119 ⁷ / ₈	390 lbs.
	Std.	80 ³ / ₈	28 ⁵ / ₈	119 ⁷ / ₈	540 lbs.
	Ext.	80 ³ / ₈	45	119 ⁷ / ₈	705 lbs.

Plenum Dimensions - Metric - (mm)

		A	B	C	Weight
Unit Sizes 20-38	Low	1648	625	2435	147.4 kg
	Std.	1648	822	2435	195.0 kg
	Ext.	1648	1143	2435	320.0 kg
Unit Sizes 42-80	Low	2042	537	3045	176.9 kg
	Std.	2042	727	3045	244.9 kg
	Ext.	2042	1143	3045	320.0 kg

Dimensions and Weights

Airside Economizer

Airside Economizer

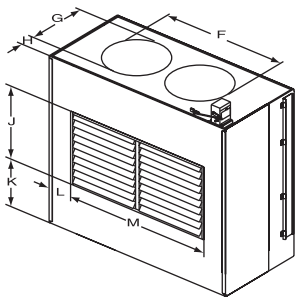
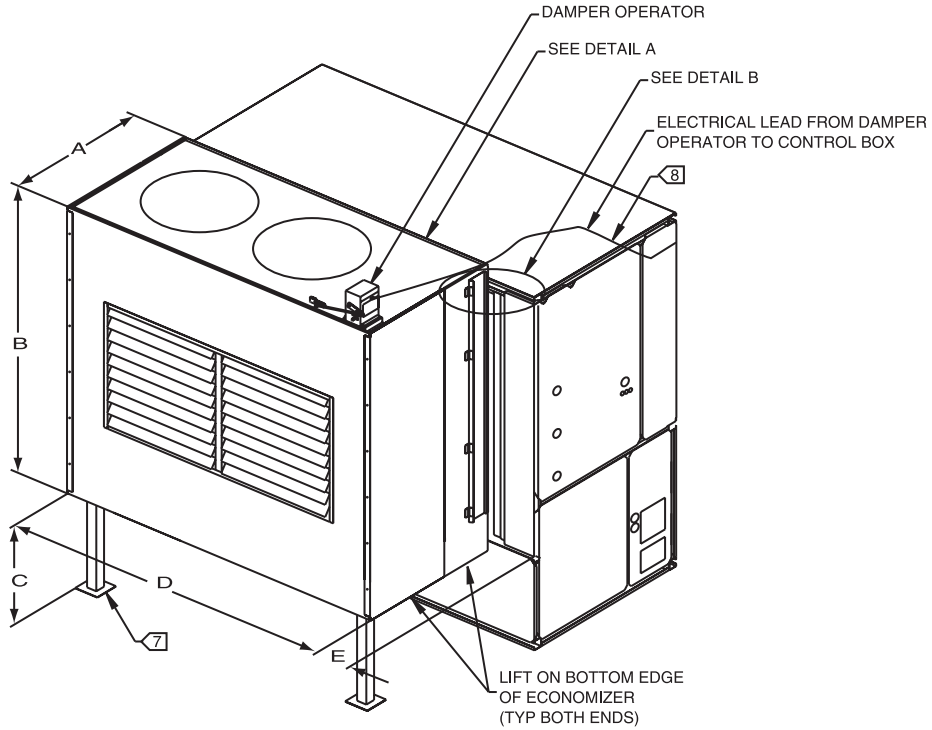

(1) DETAIL A SHOWS THE AIRSIDE ECONOMIZER WITH ALL DAMPER CONFIGURATIONS CURRENTLY AVAILABLE AND ALL OPENING DIMENSIONS (NECESSARY FOR DUCT WORK).

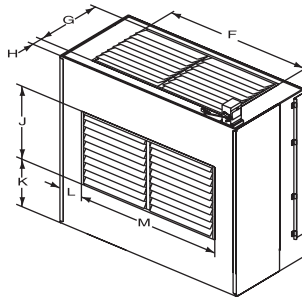

(2)

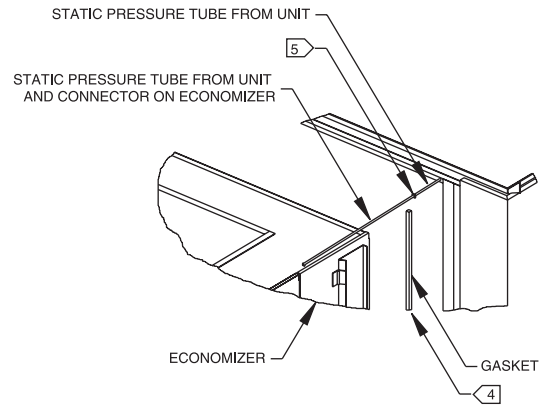



Dimensions and Weights

Airside Economizer

Airside Economizer Dimensions - English - (inches)

Unit Model	A	B	C	D	E	F (1)	F (2)	G (1)	G (2)	H (1)	H (2)	J	K	L	M
20 SXWF	44	74	22 ³ / ₈	81 ³ / ₄	8 ³ / ₄	66 ³ / ₄	49 ³ / ₄	23 ¹ / ₄	20 ¹ / ₂	9 ³ / ₄	11 ¹ / ₈	20 ¹ / ₂	22 ¹ / ₄	16	49 ³ / ₄
20 SXRF 25 SXRF	44	74	22 ³ / ₈	81 ³ / ₄	8 ³ / ₄	68 ⁵ / ₈	49 ³ / ₄	28 ¹ / ₈	20 ¹ / ₂	7 ¹ / ₄	11 ¹ / ₈	20 ¹ / ₂	22 ¹ / ₄	16	49 ³ / ₄
22 SXWF 29 SXWF	44	74	22 ³ / ₈	81 ³ / ₄	8 ³ / ₄	68 ⁵ / ₈	49 ³ / ₄	28 ¹ / ₈	20 ¹ / ₂	7 ¹ / ₄	11 ¹ / ₈	20 ¹ / ₂	22 ¹ / ₄	16	49 ³ / ₄
29 SXRF 32 SXWF	44	74	22 ³ / ₈	81 ³ / ₄	8 ³ / ₄	74 ¹ / ₄	62 ³ / ₄	23 ¹ / ₄	20 ¹ / ₂	9 ³ / ₄	11 ¹ / ₈	20 ¹ / ₂	22 ¹ / ₄	9 ¹ / ₂	62 ³ / ₄
30 SXRF 35 SXRF	44	74	22 ³ / ₈	81 ³ / ₄	8 ³ / ₄	73 ¹ / ₂	62 ³ / ₄	33	20 ¹ / ₂	4 ⁷ / ₈	11 ¹ / ₈	20 ¹ / ₂	22 ¹ / ₄	9 ¹ / ₂	62 ³ / ₄
35 SXWF 38 SXWF	44	74	22 ³ / ₈	81 ³ / ₄	8 ³ / ₄	73 ¹ / ₂	62 ³ / ₄	33	20 ¹ / ₂	4 ⁷ / ₈	11 ¹ / ₈	20 ¹ / ₂	22 ¹ / ₄	9 ¹ / ₂	62 ³ / ₄
42 SXWF	57 ³ / ₈	86 ¹ / ₂	13 ¹ / ₄	104 ³ / ₈	8 ⁷ / ₈	83 ⁵ / ₈	63 ¹ / ₂	33	26	2 ¹ / ₂	15	26	24 ³ / ₄	20 ³ / ₈	63 ¹ / ₂
40 SXRF 46 SXWF	57 ³ / ₈	86 ¹ / ₂	13 ¹ / ₄	104 ³ / ₈	8 ⁷ / ₈	94 ¹ / ₈	63 ¹ / ₂	28 ¹ / ₈	26	6 ⁷ / ₈	15	26	24 ³ / ₄	20 ³ / ₈	63 ¹ / ₂
50 SXRF 60 SXRF 52-80 SXWF	57 ³ / ₈	86 ¹ / ₂	13 ¹ / ₄	104 ³ / ₈	8 ⁷ / ₈	96 ⁵ / ₈	63 ¹ / ₂	52	37 ¹ / ₂	1 ⁷ / ₈	9 ¹ / ₄	37 ¹ / ₂	19	20 ³ / ₈	63 ¹ / ₂

Airside Economizer Dimensions - Metric - (mm)

Unit Model	A	B	C	D	E	F (1)	F (2)	G (1)	G (2)	H (1)	H (2)	J	K	L	M
20 SXWF	1118	1880	568	2076	222	1695	1264	591	521	248	283	521	565	406	1264
20 SXRF	1118	1880	568	2076	222	1743	1264	714	521	184	283	521	565	406	1264
22 SXWF 29 SXWF	1118	1880	568	2076	222	1743	1264	714	521	184	283	521	565	406	1264
29 SXRF 32 SXWF	1118	1880	568	2076	222	1886	1594	591	521	248	283	521	565	241	1594
30 SXRF 35 SXRF	1118	1880	568	2076	222	1867	1594	838	521	124	283	521	565	241	1594
35 SXWF 38 SXWF	1118	1880	568	2076	222	1867	1594	838	521	124	283	521	565	241	1594
42 SXWF	1457	2197	337	2651	225	2124	1613	838	660	64	381	660	629	518	1613
40 SXRF 46 SXWF	1457	2197	337	2651	225	2390	1613	714	660	175	381	660	629	518	1613
50 SXRF 60 SXRF 52-80 SXWF	1457	2197	337	2651	225	2454	1613	1321	953	48	235	953	483	518	1613

Dimensions and Weights

Field-Installed Zone Sensors

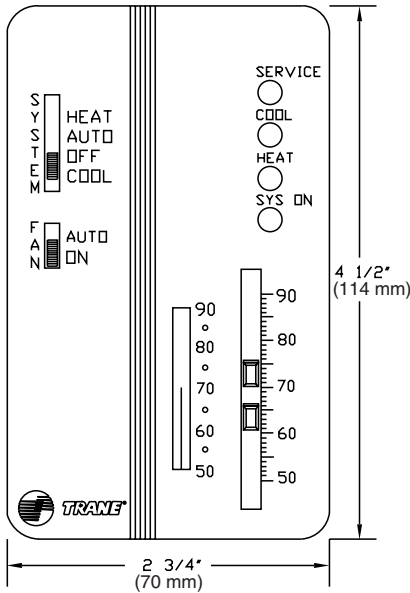

Dual Setpoint, Manual/Automatic Changeover Sensor With System Function Lights
BAYSENS010

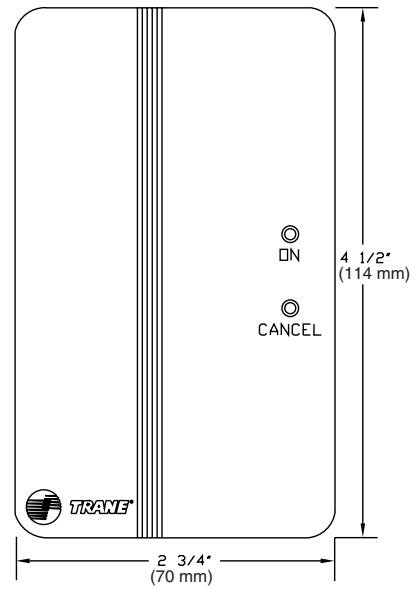

Zone Temperature Sensor W/Timed Override Buttons
BAYSENS013

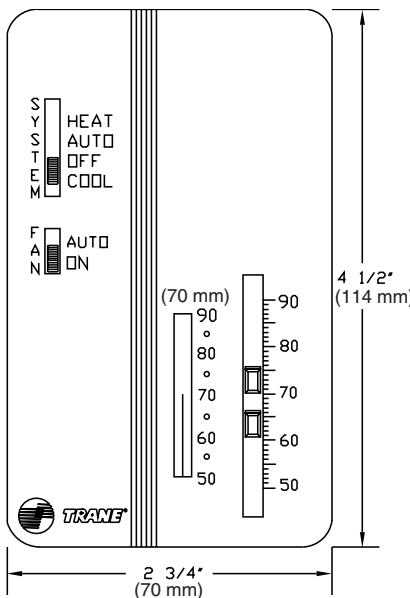

Dual Setpoint, Manual/Automatic Changeover Sensor
BAYSENS008

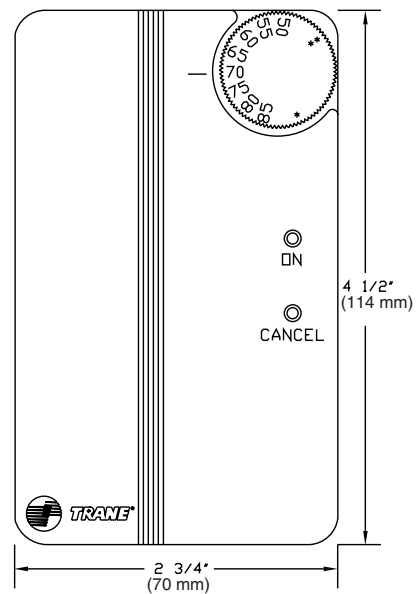

Zone Temperature Sensor W/Timed Override Buttons and Local Setpoint Adjustment
BAYSENS014

NOTE: Remote sensors are available for use with all zone sensors to provide remote sensing capabilities.

Dimensions and Weights

Field-Installed Zone Sensors

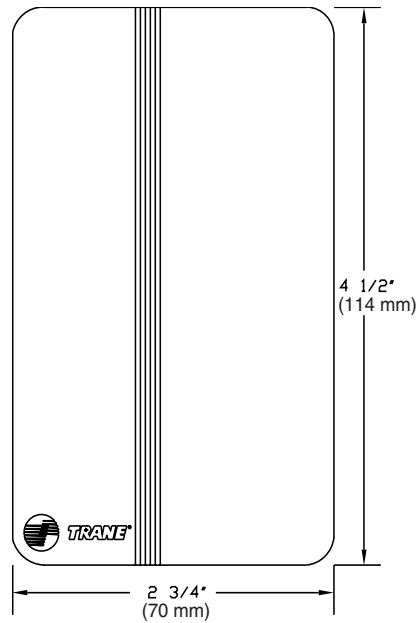

Zone Temperature Sensor Only
BAYSENS017

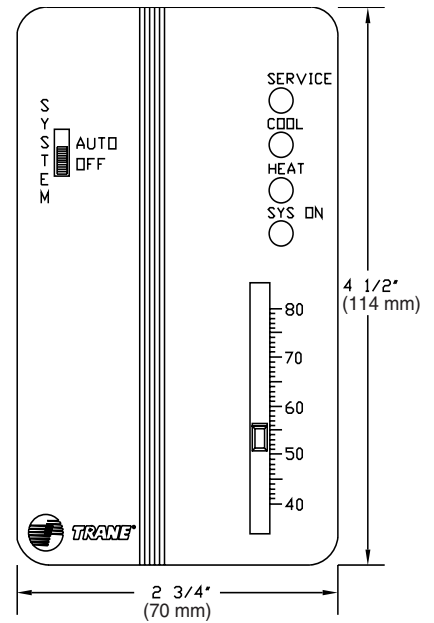

Single Setpoint Sensor With System Function Lights
BAYSENS021

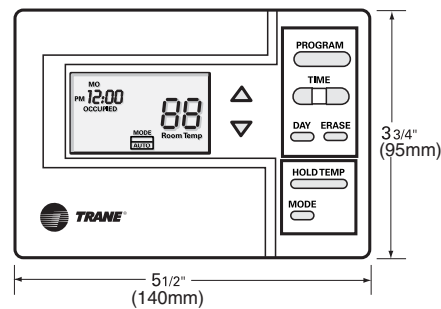

Programmable Night-Setback Sensor
BAYSENS020B

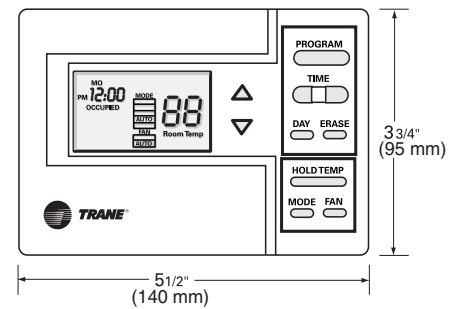

Programmable Night Setback Sensor
BAYSENS019B



Dimensions and Weights

Service Clearances

Self-Contained Models SCWF/SIWF/SCRF/SIRF

Service/Code Clearance Requirements

Side	Distance	Purpose
Front	42 in. (1066 mm) (20-38 Ton)	NEC code requirement
	48 in. (1219 mm) (42-80 Ton)	Fan service/removal
Left	36 in. (914 mm)	Filter, refrigeration and waterside component service
Right	9 in. (229 mm)	Non VFD w/ open return
	18 in. (457 mm)	Non VFD w/ ducted return
	24 in. (610 mm)	w/ VFD 7.5 to 20 HP
	36 in. (914 mm)	w/ VFD 25 to 50 HP
Inlet	18 in. (457 mm)	Provides uniform airflow

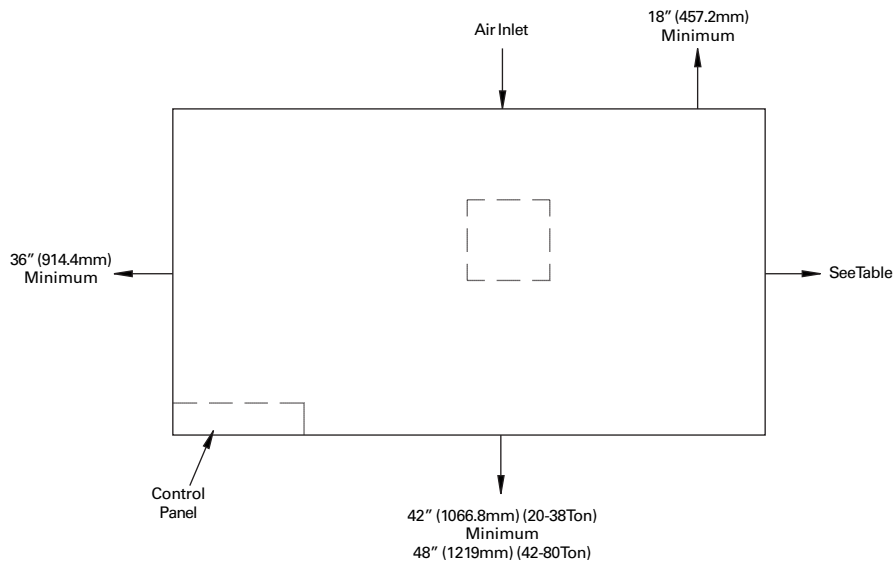

**Top View
SCWF/SCRF/SIWF/SIRF**

Dimensions and Weights

Service Clearances

Remote Air-Cooled Condensers Models CCRC/CIRC

Top View
CCRC/CIRC 20, 29

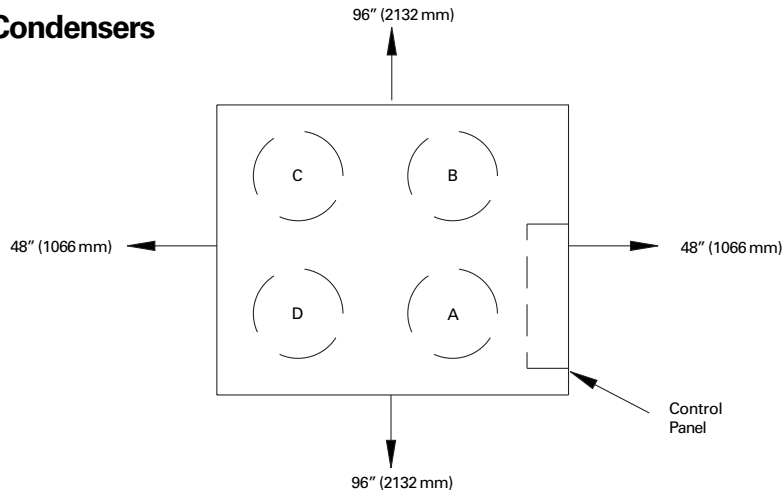

Top View
CCRC/CIRC 35, 40

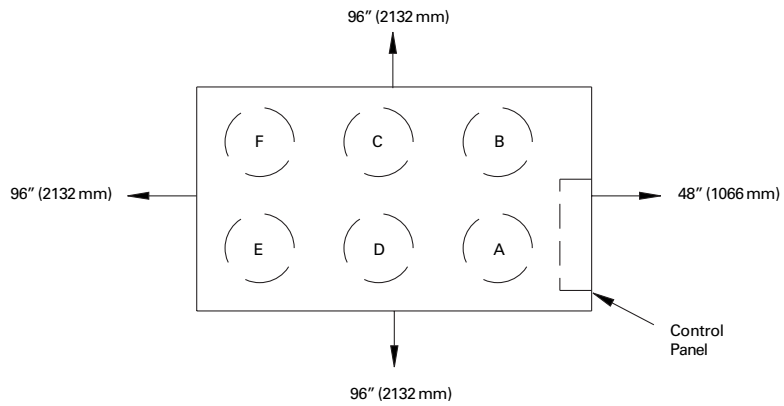

Top View
CCRC/CIRC 50, 60

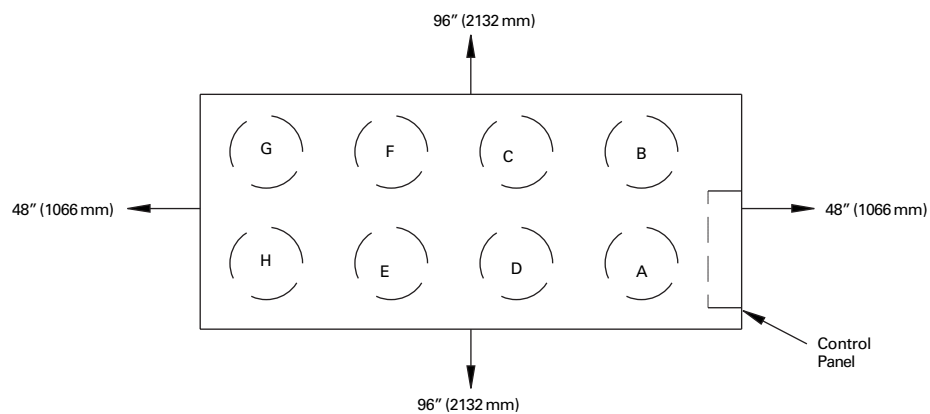



Dimensions and Weights

Weights

Table W-1. Unit Weights - SCWF/SCRF/SIWF/SIRF

	Unit Size	Base Weight lbs. (kg)	Airside Economizer lbs. (kg)	2-Row Waterside Economizer lbs. (kg)	4-Row Waterside Economizer lbs. (kg)	Heating Coil Box lbs. (kg)
SCWF/SIWF	20	3010 (1365)	430 (195)	140 (65)	340 (155)	460 (210)
	22	3010 (1365)	430 (195)	140 (65)	340 (155)	460 (210)
	25	3080 (1400)	430 (195)	140 (65)	340 (155)	460 (210)
	29	3300 (1500)	500 (225)	190 (85)	390 (175)	460 (210)
	32	3490 (1585)	500 (225)	190 (85)	390 (175)	460 (210)
	35	3610 (1640)	500 (225)	280 (130)	505 (230)	460 (210)
	38	3710 (1685)	500 (225)	280 (130)	505 (230)	460 (210)
	42	4560 (2070)	640 (290)	255 (115)	505 (230)	600 (270)
	46	4650 (2110)	640 (290)	255 (115)	505 (230)	600 (270)
	52	4970 (2255)	700 (315)	335 (150)	665 (300)	600 (270)
	58	5220 (2365)	700 (315)	335 (150)	665 (300)	600 (270)
	65	5430 (2465)	800 (360)	335 (150)	665 (300)	600 (270)
	72	5550 (2520)	800 (360)	335 (150)	665 (300)	600 (270)
80	5940 (2695)	800 (360)	335 (150)	665 (300)	600 (270)	
SCRF/SIRF	20	2920 (1325)	430 (195)	140 (65)	340 (155)	460 (210)
	25	3140 (1425)	500 (225)	190 (85)	390 (175)	460 (210)
	29	3330 (1510)	500 (225)	190 (85)	390 (175)	460 (210)
	30	3370 (1530)	500 (225)	280 (130)	505 (230)	460 (210)
	35	3470 (1575)	500 (225)	280 (130)	505 (230)	460 (210)
	40	4410 (2000)	640 (290)	255 (115)	505 (230)	600 (270)
	50	4980 (2260)	700 (315)	335 (150)	665 (300)	600 (270)
	60	5620 (2550)	800 (360)	335 (150)	665 (300)	600 (270)

Notes:

- All unit weights include refrigerant, water, inlet guide vanes and controllers, electric heat and valves.
- Add 150 lbs. to total weight to obtain approximate shipping weight.
- Flexible horizontal discharge plenum option weights:
45-inch plenum = 705 lbs.
Standard height plenum = 430 lbs.
Low height plenum = 325 lbs.

Table W-2. Unit Weights - CCRC/CIRC

Unit Size	Shipping Weight lbs. (kg)	Operating Weight lbs. (kg)
CCRC/CIRC 20	2030 (920)	1906 (865)
CCRC/CIRC 29	2084 (945)	1960 (890)
CCRC/CIRC 32	2138 (970)	2014 (915)
CCRC/CIRC 35	3018 (1370)	2833 (1285)
CCRC/CIRC 40	3072 (1395)	2887 (1310)
CCRC/CIRC 50	3995 (1810)	3695 (1675)
CCRC/CIRC 60	4275 (1940)	3975 (1805)

Table W-3. Variable Frequency Drive Weights

Motor HP Weight	Voltage	lbs. (kg)
7.5	200V	26 (12)
7.5	460V	15 (7)
10	200V	26 (12)
10	460V	26 (12)
15	200V	75 (34)
15	460V	26 (12)
20	200V	75 (34)
20	460V	31 (14)
25	200V	126 (57)
25	460V	75 (34)
30	200V	126 (57)
30	460V	75 (34)
40	200V	126 (57)
40	460V	75 (34)
50	460V	126 (57)

Mechanical Specifications

Self-Contained

Signature Series Self-Contained Units

Cabinet

The unit framework shall be formed structural steel members of 14-gauge galvanized steel. Exterior panels shall be fabricated from 18-gauge galvanized steel. The fan and compressor sections shall be insulated with ¾-inch (19 mm) of 1.75 lb./cu. ft. (28 kg./cu. ft.) density fiberglass insulation.

The unit shall be provided with removable panels to allow service access to compressors, condensers, fan motor, fan bearings, coils, and valves. Removable panels shall be secured with quick-acting fasteners. The refrigerant sight glasses shall be accessible during operation. The control panel door shall have lift-off hinges.

Compressors

Units shall have multiple compressors with independent circuits for water-cooled units and manifolded circuits for air-cooled units. Compressors shall be manufactured by the unit manufacturer. Scroll compressors shall be heavy duty suction cooled type with suction screen, centrifugal oil pump with dirt separator, oil charging valve, and oil sight glass. Protective devices for low pressure, high pressure, and motor temperature shall be provided. The compressors shall be mounted on isolators for vibration isolation.

Condenser (SCWF/SIWF only)

One condenser shall be provided for each compressor. The condensers shall be shell-and-tube design with removable heads and mechanically cleanable tubes. Tubes shall be ¾-inch (19mm) OD and constructed of copper. Condenser waterside working pressure shall be 400 psig. All condenser water piping including, cleanouts, shall be factory installed to provide single connections for water inlet and outlet.

Evaporator

The evaporator coil shall be seamless copper tubes expanded into aluminum fins. Tubes shall be ½-inch (13mm) OD with internally enhanced surfaces. Coil shall have staggered tube arrangement

with intertwined circuiting and no more than 12 fins per inch.

The drain pan shall be positively sloped in all directions to ensure proper condensate removal. The drain pan shall be fabricated of galvanized steel and insulated with ¾-inch (19 mm) of 1-lb. (0.5 kg) density fiberglass. Drain piping, including a trap with cleanout, shall be provided with a single-point connection to the unit's exterior.

Refrigerant Circuit (SCWF only)

Refrigerant circuits shall be independent and completely piped including sight glasses, distributors, thermal expansion valves with adjustable superheat and external equalizer, and high pressure relief valves with ½-inch (13 mm) flare connection. Filter driers ship loose for field installation. Unit shall be provided with adequate means of frost control. The circuits shall be factory dehydrated, charged with oil and refrigerant 22. Compressors shall be mounted on rubber-in-shear isolators for vibration isolation.

Refrigerant Circuit (SCR/SIRF only)

Two refrigerant circuits shall be piped to the unit's exterior. The refrigerant piping includes filter driers (for field installation), sight glasses, distributors, thermal expansion valves with adjustable superheat and external equalizer. Unit shall be provided with adequate means of frost control. The circuits shall be factory tested, dehydrated and then charged with dry nitrogen. Compressors shall be mounted on rubber-in-shear isolators for vibration isolation.

Supply Fan

The supply fan shall be a single forward curved medium pressure fan secured to a solid steel shaft with grease lubricated bearings designed for 200,000 hours. Both fan bearings shall have greaselines extended to a common location. The drive components shall include fixed pitch sheaves and multiple V-belt sized for 130% nominal motor horsepower. The supply fan motor shall have a service factor of 1.15. The supply fan motor shall be either:

- Standard efficiency open drip-proof
- Premium efficiency open drip-proof
- Totally enclosed fan cooled standard

efficiency.

Supply fan motor shall have a standard T-frame. All drive components shall be accessible without using scaffolds or ladders.

The entire fan assembly, including drive components, shall be mounted on a common base. The fan base shall be isolated inside the unit. The entire assembly shall be statically and dynamically balanced at the factory.

Filters

Two-inch (51 mm) throwaway fiberglass filters shall be provided for installation during construction.

Unit Controls - DDC

Microprocessor controls shall be provided to control all unit functions. The control system shall be suitable to control CV or VAV applications. The controls shall be factory-installed and mounted in the main control panel. All factory-installed controls shall be fully commissioned (run tested) at the factory. The unit shall have a human interface panel with 16-key keypad, a two line, 40 character clear language (English, French, or Spanish) display as standard to provide the operator with full adjustment and display of control data functions. The unit controls shall be used as a stand-alone controller or as part of a building management system involving multiple units.

The unit shall be equipped with a complete microprocessor control system. This system shall consist of temperature and pressure (thermistor and static pressure transducer) sensors, printed circuit boards (modules) and a unit mounted human interface panel. Modules (boards) shall be individually replaceable for service ease. All microprocessors, boards, and sensors shall be factory mounted, wired, and tested.

The microprocessor boards shall be stand-alone DDC controls not dependent on communications with an on-site PC or building management network. The microprocessors shall be equipped with on-board diagnostics, indicating that all hardware, software, and interconnecting wiring are in proper operating condition. The modules (boards) shall be protected to prevent RFI and voltage transients from affecting the board's circuits. All field



Mechanical Specifications

Air-Cooled Condenser

wiring shall be terminated at a separate, clearly marked terminal strip. Direct field wiring to the I/O boards is not acceptable. The microprocessor's memory shall be nonvolatile EEPROM type requiring no battery or capacitive backup, while maintaining all data.

Zone sensors shall be available in several combinations with selectable features depending on sensor.

The human interface panel's keypad display character format shall be 40 characters x two lines. The character font shall be 5 x 7 dot matrix plus cursor. The display shall be supertwist liquid crystal display (LCD) with blue characters on a gray/green background which provides high visibility and interface ease. The display format shall be in clear language: English, French, or Spanish.

The keypad shall be equipped with 16 individual touch sensitive membrane key switches. The switches shall be divided into four separate sections and password protected to prevent tampering by unauthorized personnel. The six main menus shall be STATUS, SETPOINTS, DIAGNOSTICS, SETUP, CONFIGURATION, and SERVICE MODE.

Agency Listing

The unit shall have the US/Canada Underwriter's Laboratory agency listing.

Remote Air-Cooled Condenser

Cabinet

The unit framework shall be formed structural steel members of 14-gauge galvanized steel. Panels and access doors shall be 18-gauge galvanized steel. The unit exterior shall be phosphatized and finished with air-dried enamel paint.

Refrigerant Circuits and Controls

All sizes shall have dual refrigerant circuits and shall include an integral subcooling circuit for each circuit. All necessary controls to run unit fans shall be factory installed. The control panel shall include fan motor contactors, terminal block connection for compressor interlock, and 115-volt control power transformer.

Condenser Coils

The condenser coil arrangement shall be slab type. Coils shall be seamless $\frac{3}{8}$ -inch (10mm) OD copper tubes expanded into aluminum fins. Each circuit shall include an integral subcooler. The coil shall be leak tested at 450 psig air pressure.

Condenser Fans and Motor

Vertical discharge direct drive fans shall be statically and dynamically balanced at the factory. Motors shall be three-phase with permanently lubricated ball bearings, built-in current and thermal overload protection and weathertight rain slinger over the fan shaft.

Protective Coating (Option)

Unit

The unit's interior and exterior shall have a 4 to 6 mil coat of protective coating applied with an air-dry process.

Condenser Coils

The condenser coil shall have a 4 to 6 mil coat of protective coating applied by a multiple dip-and-bake process.

Low Ambient Operation Option

Standard ambient control allows operation down to 45 F (-7.2 C) by cycling the condenser fans. Low ambient control damper shall allow the unit to operate down to 0 F (-17.8 C) by utilizing additional fan cycling and an external damper assembly. The low ambient control damper shall include a 16-gauge damper assembly. The damper is controlled by the air-cooled unit's DDC controller.

Louvered Coil Guards Option

The unit coils shall be covered with a factory installed decorative louvered grill type panel for protection.

Agency Listing

The unit shall have the US/Canada Underwriter's Laboratory agency listing.

Mechanical Specifications

Options

Self-Contained Options

Air Volume/Temperature Control

- **Zone Temperature Control**

This option includes a zone sensor, microprocessor unit control module, a microprocessor compressor controller, and a unit-mounted human interface panel. The unit operates at a design airflow based on the fan and motor drive selections.

- **Supply Air Temperature Control with Inlet Guide Vanes**

This option controls supply air temperature to the specified supply air cooling setpoint by modulating the economizer option and/or staging mechanical cooling on and off as required. Control components include a discharge air microprocessor controller, discharge air sensor, pressure sensor, and inlet guide vanes. The microprocessor controller coordinates the economizer control and the cooling stages with zone or outdoor air reset capabilities and an adjustable control band to fine-tune the control to specific applications. The inlet guide vanes (IGV) operate with the self-contained unit to control duct static pressure. The IGV option includes vanes and static pressure controls.



Inlet Guide Vanes

- **Supply Air Temperature Control With Variable Frequency Drive**

This option controls the VAV self-contained unit from the discharge air temperature using a factory mounted variable frequency drive (VFD). The VFD safely varies the fan motor speed to allow

the motor to meet the dynamic requirements at the motor shaft and meet the system static. Other control components include a discharge air microprocessor controller and discharge air sensor. The microprocessor controller coordinates the economizer control and the stages of cooling with discharge air temperature reset capabilities. Includes factory installed and tested variable frequency drive (VFD) to provide supply fan motor speed modulation. The VFD receives 0-10vdc signal from the unit microprocessor based upon supply static pressure and causes the drive to accelerate or decelerate as required to maintain the supply static pressure setpoint.

- **Supply Air Temperature Control With Variable Frequency Drive with Bypass**

Manual bypass control provides full nominal airflow and zone temperature control in the event of a drive failure. The VFD with bypass is factory mounted completely wired and tested. A motor overload relay and fuses are provided to properly size motor protection during both drive and bypass modes.

- **Waterside Economizer**

The waterside economizer takes advantage of cooling tower water to either pre-cool the entering air to aid the mechanical cooling process or, provides total system cooling if the water temperature is low enough. Waterside economizing enables when the unit's entering water temperature is below the unit's entering mixed air temperature by a minimum of 4 F plus the economizer's approach temperature. The approach temperature default is 4 F and is adjustable from 0 to 9 F. Waterside economizing disables when the unit's entering water temperature is not below the unit's entering mixed air temperature by at least the water economizer approach temperature. The economizer acts as the first stage of cooling. If the economizer is unable to maintain the supply air setpoint, the unit control module brings on compressors as required to meet the setpoint. The waterside economizer includes a coil, modulating valves, controls, and piping with cleanouts. All components are factory installed in the unit cabinet. The coil construction is 1/2-inch (13mm) OD

seamless copper tubes expanded into aluminum fins. The evaporator and economizer coils share a common sloped (IAQ) drain pan. Drain pan options are either galvanized or stainless steel and insulated and internally trapped.

The waterside economizer coil options have either two or four rows with no more than 12 fins per inch. The tubes are arranged in a staggered pattern to maximize heat transfer. The coil has round copper supply and return headers with removable cleanout and vent plugs. The optional mechanically cleanable economizer has removable cast iron headers to allow easy mechanical cleaning of the tubes. The waterside working pressure is rated for 400 psig (2758 kPa).

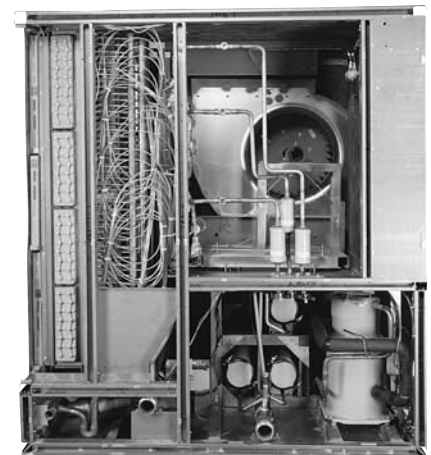

Side View of Unit with Waterside Economizer with Removable Headers



Mechanical Specifications

Options

Airside Economizer

Units with the airside economizer option are equipped with the necessary control sequences to use outside air for the first stage of cooling, in occupied or unoccupied mode and when ambient conditions are favorable for economizing. Inherent in the unit controller is the ability to suppress the setpoint below the normal unit setpoint. This allows the building to improve comfort levels when possible, and at the same time, optimize building mechanical cooling operation for peak operating efficiency. An outside air temperature and relative humidity sensor are provided to allow monitoring of reference enthalpy and are field installed. Economizer operation enables when the outside air enthalpy is less than 25 BTU's/lb. default (adjustable 19-28 BTU's/lb.). During occupied mode, the outside air damper opens to 15% (adjustable 0-100%) for ventilation purposes. Also, the ability to alter the outside air damper position to compensate for VAV supply air modulation is inherent in the unit controls, and can be enabled by the operator.

The mixing box fabrication is 16-gauge galvanized steel. Opposed low leak damper blades are fabricated from 16-gauge galvanized steel and rotate on rustproof nylon bushings. A factory installed 24V modulating spring return actuator controls both damper positions.

• Comparative Enthalpy Control

Units with comparative enthalpy control are equipped with the necessary control sequences to allow using outside air for the first stage of cooling, in occupied or unoccupied mode and when ambient conditions are favorable for economizing. Inherent in the unit controller is the ability to suppress the setpoint below the normal unit setpoint. This allows the building to improve comfort levels when possible, and at the same time, optimize building mechanical cooling operation for peak operating efficiency. A factory-installed control board, with field-installed outside and return air temperature and relative humidity sensors, allows monitoring of outside and return air. Economizer operation enables when the outside air enthalpy is 3 BTU's/lb. less than the return air enthalpy. During occupied mode, the outside air damper opens to 15% (adjustable 0-100%) for ventilation

purposes. Also, the ability to alter the outside air damper position to compensate for VAV supply air modulation is inherent in the unit controls, and can be enabled by the operator.

The mixing box fabrication is 16-gauge galvanized steel. Opposed low leak damper blades are fabricated from 16-gauge galvanized steel and rotate on rustproof nylon bushings. A factory installed 24V modulating spring return actuator controls both damper positions.

• Standard Two-Position Damper Interface

Units with the two-position damper interface are provided with a 0-10 VDC control output suitable for controlling a field-provided modulating actuator. In occupied mode, the output drives to the maximum position.

• Airside Economizer Interface

Units with airside economizer interface are equipped with the necessary control sequences to allow using outside air for the first stage of cooling, in occupied or unoccupied mode and when ambient conditions are favorable for economizing. Inherent in the unit controller is the ability to suppress the setpoint below the normal unit setpoint. This allows the building to improve comfort levels when possible, and at the same time, optimize building mechanical cooling operation for peak operating efficiency. An outside air temperature and relative humidity sensor are provided for field installation to monitor reference enthalpy. Economizer operation enables when the outside air enthalpy is less than 25 BTU's/lb. (adjustable 19-28 BTU's/lb.). During occupied mode, the outside air damper opens to 15% (adjustable 0-100%) for ventilation purposes. Also, the ability to alter the outside air damper position to compensate for VAV supply air modulation is inherent in the unit controls, and can be enabled by the operator. An analog 2-10 VDC output (adjustable 0-10 VDC) is provided to modulate the field-provided 30 second damper actuators (adjustable 1-255 seconds).

• Airside Economizer Interface with Comparative Enthalpy

Units with airside economizer interface and comparative enthalpy are equipped with the necessary control sequences to

allow using outside air for the first stage of cooling, in occupied or unoccupied mode and when ambient conditions are favorable for economizing. Inherent in the unit controller is the ability to suppress the setpoint below the normal unit setpoint. This allows the building to improve comfort levels when possible, and at the same time, optimize building mechanical cooling operation for peak operating efficiency. A factory-installed control board, with outside and return air temperature and relative humidity sensors, are provided for monitoring outside and return air. The sensors are field installed. Economizer operation enables when the outside air enthalpy is 3 BTU's/lb. less than the return air enthalpy. During occupied mode, the outside air damper opens to 15% (adjustable 0-100%) for ventilation purposes. Also, the ability to alter the outside air damper position to compensate for VAV supply air modulation is inherent in the unit controls, and can be enabled by the operator. An analog 2-10 VDC output (adjustable 0-10 VDC) is provided to modulate the field-provided 30-second damper actuators (adjustable 1-255 seconds).

Basic Water Piping

This option is available on units without a waterside economizer and with condenser water applications above 54 F (12.2 C) that do not require condensing pressure control. Left hand water connections and piping are extended to the unit exterior. Manifold piping is factory installed.

Intermediate Water Piping

This option provides condensing temperature control when the unit is configured (user defined at the HI) for variable water flow with or without a waterside economizer. A two-way modulating control valve is wired and installed in the unit to maintain a specific range of water temperature rise through the condenser when entering fluid temperature is less than 58 F (15 C). This option allows the compressor to operate with entering fluid temperature down to 35 F (2 C). The minimum valve position to maintain minimum condenser flow rates is user-defined at the human interface. This valve drives closed if the unit shuts down or if a power failure occurs.

Mechanical Specifications

Options

Waterside Economizer Flow Control

Units equipped with a waterside economizer can be set from the human interface panel for variable or constant water flow.

• Constant Water Flow

Two-way modulating control shutoff valves are wired, controlled, and installed in the unit. One valve is located in the economizer's water inlet, and the other is in the condenser bypass water inlet. When the waterside economizer enables, the two-way valve modulates to maintain the discharge air temperature setpoint. As the economizer valve opens, the condenser bypass valve closes, and vice versa. Full water flow is always maintained through the condensers. Both valves will close in the event of a power failure.

• Variable Water Flow

Two-way modulating control shutoff valves are wired, controlled, and installed in the unit. One valve is located in the economizer's water inlet, and the other is in the condenser bypass water inlet. When the economizer valve is active, the condenser bypass valve closes. The economizer valve modulates, thus water flow through the unit modulates. If the water is cool enough for economizing, but mechanical cooling is also required, the economizer valve fully opens to establish full water flow through the condensers. Whenever the water is too warm for economizing and there is a call for cooling, the economizer valve fully closes and the bypass valve fully opens, establishing full water flow through the condensers. Full water flow is always maintained through the condensers when mechanical cooling is required. Both valves close whenever cooling is not required and in the event of a power failure.

Water Flow Switch

A water flow switch is factory installed in the condenser water pipe within the unit. Whenever the flow switch detects a water flow loss prior to or during mechanical cooling, compressor operation locks out and a diagnostic code displays. If water flow is restored, the compressor operation automatically restores.

Service Valves

Service valves are factory installed on each circuit before and after the compressor to allow compressor isolation for servicing.

Heating Coils

• Electric Heat

A single stage electric heating coil and controls are factory installed inside the unit casing at the fan discharge. An open construction type coil is provided. Power to the electric heater is factory wired to the unit's single-point power connection.

• Hot Water

The hot water heating assembly includes the coil and filter section and is factory installed on the unit's inlet. A three-way modulating valve, actuator, manifold piping, and automatic air vent are also factory installed. The coil is a Trane type WC, constructed of $\frac{5}{8}$ -inch (16 mm) OD copper tubes arranged in a parallel pattern. The copper tubes are expanded into aluminum fins positioned continuously across the entire coil width, not exceeding 12 fins per inch. The coil casing is 16-gauge steel. Coil performance is rated at a maximum working pressure of 200 psig in accordance with ARI Standard 410. Supply and return water header connections are female tapered NPT and are accessed from the unit's left side.

• Steam

The steam heating assembly includes the coil and filter section, factory installed on the unit's inlet. A two-way modulating valve, actuator, and manifold piping are also factory installed. Also, connections are provided for field installing a vacuum breaker. The coil is a Trane type NS, constructed of one inch (25 mm) OD copper tubes arranged in a parallel pattern. The copper tubes are expanded into aluminum fins positioned continuously across the entire coil width, not exceeding 42 fins per foot. The coil casing is 16-gauge steel. Coil performance is rated at a maximum working pressure of 100 psig in accordance with ARI Standard 410. Supply and return steam header connections are female tapered NPT and are accessed from the unit's left side.

Factory provided controls limit the steam coil leaving air temperature to no more than 105 F (41 C) at all operating conditions.

Single Stage Electric Heat Interface

A heat control module will be factory installed and wired for customer supplied and powered electric heat. This module will allow the unit to stage the customer-provided electric heat. Single stage electric heat control will be accomplished with one dry binary output rated at one amp for 115 VAC.

Hydronic Heating Control Interface

A heat control module will be factory installed and wired for customer supplied hydronic heating. This control will be accomplished with a dry binary output, 0-10 VDC analog control signal.

Time Clock

A factory-installed programmable time clock is wired to the unoccupied mode binary input to provide on/off control. The timer is accessible without opening the control panel door, and is a seven-day type with a maximum of four operations per day. A permanent built-in rechargeable battery pack is provided.

Low Entering Air Temperature Protection Device

A thermostat limit switch is factory mounted on the unit's entering air side with a capillary tube serpentine across the coil face. If the temperature falls below 35 F (2 C), the fan shuts down and the waterside economizer and/or hydronic heat valve option opens to allow full water flow. The heat output also energizes. A manual reset is required. Note: this option is standard on units with a waterside economizer or hydronic heat.

Non-fused Disconnect Switch

The unit has a factory mounted non-fused disconnect switch accessible without opening the control panel door.

Dual Point Power Terminal Blocks

Two separate power terminal blocks are available to bring power to the unit; one terminal block provides power to the compressors and the other provides power to the fan motor and controls. Note: a single point power terminal block is standard.

Mechanical Specifications

Options

Flexible Horizontal Discharge Plenum

• Low and Standard Height

Units are provided with a factory installed horizontal discharge plenum that permits multi-directional duct connections. The plenum is insulated with two inches (51 mm) of 1.75 lb. (0.79 kg) density fiberglass for sound attenuation. Discharge openings can either be field cut or factory cut based on duct dimensions supplied by the customer. A two-inch duct collar is provided for field duct connections. On unit sizes 20-38 tons, the low height plenum is 24 ⁵/₈ inches (625 mm) and the standard height plenum is 32 ³/₈ inches (822 mm). On unit sizes 42-80 tons, the low height plenum is 21 ¹/₈ inches (537 mm) and the standard height plenum is 28 ³/₈ inches (727 mm).

• Extended Height, 45-inch (1143m)

Units are provided with a horizontal discharge plenum that permits multi-directional duct connections. The plenum is insulated with four inches (102 mm) of 1.75 lb. (0.79 kg) density fiberglass for sound attenuation. Double-wall perf is also available. Discharge openings can either be field cut or factory cut based on duct dimensions supplied by the customer. A two-inch duct collar is provided for field duct connections.

High Duct Temperature Thermostat

A factory-supplied temperature limit switch with reset element detects the supply air duct temperature. This sensor should be field-installed downstream from the unit's discharge in the supply air duct. If the supply air duct temperature exceeds 240 F (115.6 C), the unit shuts down and displays a diagnostic. A manual reset is required at the unit. The high duct temperature can be adjusted at the thermostat.

Plenum High Static Switch

A factory supplied sensor provides additional protection from ductwork over-pressurization. This sensor should be field-installed downstream of the unit's discharge in the supply air duct.

Protective Coating

• Cabinet

The unit exterior and exposed interior surfaces have a four to six mil coat of protective coating.

• Coils

A three to five mil coat of protective coating is applied to the coil using a multiple dip-and-bake process.

Cupro-Nickel Condenser

One condenser is provided for each compressor. The condensers are a shell-and-tube design with removable heads to allow mechanical tube cleaning. Tubes are ³/₄-inch (19mm) OD and constructed of copper cupro-nickel (90/10).

Stainless Steel Drain Pan

The drain pan is positively sloped, fabricated from 304L stainless steel, and insulated with ³/₄-inch (19 mm) of 1-lb. (0.5 kg) density fiberglass. The drain pan contains a factory piped trap with cleanout.

Dirty Filter Sensor

A factory installed pressure switch senses the pressure differential across the filters. When the differential pressure exceeds 0.9-inches (23 mm) WG, contact closure occurs.

A field installed indicator device may be wired to relay terminals that indicate when filter service is required. Contacts are rated at 115 VAC and are powered by a field supplied transformer.



Dirty Filter Switch

Filters

Medium Efficiency

Two-inch (51 mm) medium efficiency throwaway fiberglass filters are installed in the unit filter section.

Remote Human Interface Panel

The remote human interface panel (RHI) can perform all the same functions as the unit mounted human interface panel, except the service mode function. A single RHI can monitor and control up to four units. The panel includes a 2 x 40 character clear language (English, Spanish, or French) display, a red LED light to indicate an alarm condition, a simple 16-key keypad for making unit setpoint and configuration changes, and hinged access door. The panel can be mounted up to 5,000 feet (1524 m) from the unit and is wired to the inter-processor communications bridge (IPCB) mounted in the unit with twisted wire pair communication wiring and 24V wiring.

Generic Building Automation System Module (GBAS)

The GBAS module is for use with a non-Trane building management system. The module provides a binary input for demand limiting, four analog inputs for setpoint adjustment, and five relay outputs for diagnostic reporting. Inputs can use a potentiometer or 0-5 vdc signal.

Ventilation Override Module (VOM)

The VOM allows you to program the unit with up to five ventilation sequences: smoke purge, evacuation, pressurization, purge, and purge with duct control. Typically, a hard-wire short from a smoke detector or fire control panel will cause a binary input on the VOM to close, thus causing the programmed sequence to occur.

Trane Communication Interface (TCI)

The TCI provides interface to a Trane Integrated Comfort™ system (ICS). It allows remote control and monitoring of the self-contained unit using a personal computer with Tracer® building management software.



TRANE®

The Trane Company
A Division of American Standard Inc.
www.trane.com

*For more information contact
your local Trane office or
e-mail comfort@trane.com*

Literature Order Number	PKG-PRC002-EN
File Number	PL-UN-PKG-PRC002-EN-1201
Supersedes	PKG-PRC002-EN 01/01
Stocking Location	La Crosse - Inland

The Trane Company has a policy of continuous product improvement and reserves the right to change design and specifications without notice.